

Satellite[®] 1955 Series User's Guide

If you need assistance:

- ❖ InTouch[®] Center
Calling within the United States (800) 457-7777
Calling from outside the United States (949) 859-4273

For more information, see [Chapter 9](#) on [page 203](#) in this guide.

Model: Satellite® 1955 Series

Compact Disk-ReWritable

The computer system you purchased may include a Compact Disk-ReWritable (CD-RW), one of the most advanced storage technologies available. As with any new technology, you must read and follow all set-up and usage instructions in the applicable user guides and/or manuals enclosed. If you fail to do so, this product may not function properly and you may lose data or suffer other damage. **TOSHIBA AMERICA INFORMATION SYSTEMS (“TOSHIBA”), ITS AFFILIATES AND SUPPLIERS DO NOT WARRANT THAT OPERATION OF THE PRODUCT WILL BE UNINTERRUPTED OR ERROR FREE. YOU AGREE THAT TOSHIBA, ITS AFFILIATES AND SUPPLIERS SHALL HAVE NO RESPONSIBILITY FOR DAMAGE TO OR LOSS OF ANY BUSINESS, PROFITS, PROGRAMS, DATA OR REMOVABLE STORAGE MEDIA ARISING OUT OF OR RESULTING FROM THE USE OF THE PRODUCT, EVEN IF ADVISED OF THE POSSIBILITY THEREOF.**

Protection of Stored Data

For your important data, please make periodic back-up copies of all the data stored on the hard disk or other storage devices as a precaution against possible failures, alteration, or loss of the data. **IF YOUR DATA IS ALTERED OR LOST DUE TO ANY TROUBLE, FAILURE OR MALFUNCTION OF THE HARD DISK DRIVE OR OTHER STORAGE DEVICES AND THE DATA CANNOT BE RECOVERED, TOSHIBA SHALL NOT BE LIABLE FOR ANY DAMAGE OR LOSS OF DATA, OR ANY OTHER DAMAGE RESULTING THEREFROM. WHEN COPYING OR TRANSFERRING YOUR DATA, PLEASE BE SURE TO CONFIRM WHETHER THE DATA HAS BEEN SUCCESSFULLY COPIED OR TRANSFERRED. TOSHIBA DISCLAIMS ANY LIABILITY FOR THE FAILURE TO COPY OR TRANSFER THE DATA CORRECTLY.**

Critical Applications

The computer you have purchased is not designed for any “critical applications.” “Critical applications” means life support systems, medical applications, connections to implanted medical devices, commercial transportation, nuclear facilities or systems or any other applications where product failure could lead to injury to persons or loss of life or catastrophic property damage. **ACCORDINGLY, TOSHIBA, ITS AFFILIATES AND SUPPLIERS DISCLAIM ANY AND ALL LIABILITY ARISING OUT OF THE USE OF THE COMPUTER PRODUCTS IN**

ANY CRITICAL APPLICATIONS. IF YOU USE THE COMPUTER PRODUCTS IN A CRITICAL APPLICATION, YOU, AND NOT TOSHIBA, ASSUME FULL RESPONSIBILITY FOR SUCH USE.

FCC Notice

This equipment has been tested and found to comply with the limits for a Class B digital device, pursuant to Part 15 of the FCC rules. These limits are designed to provide reasonable protection against harmful interference in a residential installation.

This equipment generates, uses and can radiate radio frequency energy and, if not installed and used in accordance with the instructions, it may cause harmful interference to radio communications. However, there is no guarantee that interference will not occur in a particular installation. If this equipment does cause harmful interference to radio or television reception, which can be determined by turning the equipment off and on, the user is encouraged to try to correct the interference by one or more of the following measures:

- ❖ Reorient or relocate the receiving antenna.
- ❖ Increase the separation between the equipment and receiver.
- ❖ Connect the equipment to an outlet on a circuit different from that to which the receiver is connected.
- ❖ Consult the dealer or an experienced radio/TV technician for help.



NOTE: Only peripherals complying with the FCC Class B limits may be attached to this computer. Operation with non-compliant peripherals or peripherals not recommended by Toshiba is likely to result in interference to radio and TV reception. Shielded cables must be used between the external devices and the computer's serial port, parallel port, monitor port, USB port, PS/2™ port and microphone jack. Changes or modifications made to this equipment not expressly approved by Toshiba or parties authorized by Toshiba could void the user's authority to operate the equipment.

This device complies with Part 15 of the FCC Rules. Operation is subject to the following two conditions:

- ❖ This device may not cause harmful interference.
- ❖ This device must accept any interference received, including interference that may cause undesired operation.

4

Contact:

Toshiba America Information Systems, Inc.
9740 Irvine Blvd.
Irvine, CA 92618-1697
(949) 583-3000

Industry Canada Requirement

This Class B digital apparatus complies with Canadian ICES-003.

Cet appareil numérique de la classe B est conforme à la norme NMB-003 du Canada.

FCC Requirements

The following information is pursuant to FCC CFR 47, Part 68 and refers to internal modems.

Installation

When you are ready to install or use the modem, call your local telephone company and give them the following information:

- ❖ The telephone number of the line to which you will connect the modem.
- ❖ The FCC registration number of the modem.
- ❖ The ringer equivalence number (REN) of the modem, which is 0.6B.

The modem connects to the telephone line by means of a standard jack called the USOC RJ11C.

Type of Service

Your modem is designed to be used on standard-device telephone lines. Connection to telephone company-provided coin service (central office implemented systems) is prohibited. Connection to party lines service is subject to State tariffs. If you have any questions about your telephone line, such as how many pieces of equipment you can connect to it, the telephone company will provide this information upon request.

Telephone Company Procedures

The goal of the telephone company is to provide you with the best service it can. In order to do this, it may occasionally be necessary for them to make changes in their equipment, operations or procedures. If these changes might affect your service or the operation of your equipment, the telephone

company will give you notice, in writing, to allow you to make any changes necessary to maintain uninterrupted service.

If Problems Arise

If any of your telephone equipment is not operating properly, you should immediately remove it from your telephone line, as it may cause harm to the telephone network. If the telephone company notes a problem, they may temporarily discontinue service. When practical, they will notify you in advance of this disconnection. If advance notice is not feasible, you will be notified as soon as possible. When you are notified, you will be given the opportunity to correct the problem and informed of your right to file a complaint with the FCC. In the event repairs are ever needed on your modem, they should be performed by Toshiba Corporation, Toshiba America Information Systems, Inc. or an authorized representative of Toshiba.

Disconnection

If you should ever decide to permanently disconnect your modem from its present line, please call the telephone company and let them know of this change.

Fax Branding

The Telephone Consumer Protection Act of 1991 makes it unlawful to use a computer or other electronic device to send any message via a telephone fax machine unless such message clearly contains in a margin at the top or bottom of each transmitted page or on the first page of the transmission, the date and time it is sent and an identification of the business, other entity or individual sending the message and the telephone number of the sending machine or such business, other entity or individual.

In order to program this information into your fax modem, you should complete the setup for your fax software before sending a message.

Instructions for IC CS-03 certified equipment

- 1** NOTICE: The Industry Canada label identifies certified equipment. This certification means that the equipment meets certain telecommunications network protective, operational and safety requirements as prescribed in the appropriate Terminal Equipment Technical Requirements document(s). The Department does not guarantee the equipment will operate to the user's satisfaction.

Before installing this equipment, users should ensure that it is permissible to be connected to the facilities of the local telecommunications company. The equipment must also be installed using an acceptable method of connection. The customer should be

aware that compliance with the above conditions may not prevent degradation of service in some situations.

Repairs to certified equipment should be coordinated by a representative designated by the supplier. Any repairs or alterations made by the user to this equipment, or equipment malfunctions, may give the telecommunications company cause to request the user to disconnect the equipment.

Users should ensure for their own protection that the electrical ground connections of the power utility, telephone lines and internal metallic water pipe system, if present, are connected together. This precaution may be particularly important in rural areas.

Caution: Users should not attempt to make such connections themselves, but should contact the appropriate electric inspection authority, or electrician, as appropriate.

- 2 The user manual of analog equipment must contain the equipment's Ringer Equivalence Number (REN) and an explanation notice similar to the following:

The Ringer Equivalence Number (REN) of this device can be found on the label affixed to your computer.

NOTICE: The Ringer Equivalence Number (REN) assigned to each terminal device provides an indication of the maximum number of terminals allowed to be connected to a telephone interface. The termination on an interface may consist of any combination of devices subject only to the requirement that the sum of the Ringer Equivalence Numbers of all the devices does not exceed 5.

- 3 The standard connecting arrangement (telephone jack type) for this equipment is jack type(s): USOC RJ11C.

Wireless Interoperability

The Toshiba Wireless LAN Mini PCI Card products are designed to be interoperable with any wireless LAN product that is based on Direct Sequence Spread Spectrum (DSSS) radio technology, and is compliant to:

- ❖ The IEEE 802.11 Standard on Wireless LANs (Revision B), as defined and approved by the Institute of Electrical and Electronics Engineers.
- ❖ The Wireless Fidelity (Wi-Fi™) certification as defined by the WECA Wireless Ethernet Compatibility Alliance.

Wireless LAN and your Health

Wireless LAN products, like other radio devices, emit radio frequency electromagnetic energy. The level of energy emitted by Wireless LAN devices however is far much less than the electromagnetic energy emitted by wireless devices like for example mobile phones. Because Wireless LAN products operate within the guidelines found in radio frequency safety standards and recommendations, Toshiba believes Wireless LAN is safe for use by consumers. These standards and recommendations reflect the consensus of the scientific community and result from deliberations of panels and committees of scientists who continually review and interpret the extensive research literature.

In some situations or environments, the use of Wireless LAN may be restricted by the proprietor of the building or responsible representatives of the organization. These situations may for example include:

- ❖ Using the Wireless LAN equipment on board of airplanes, or
- ❖ In any other environment where the risk of interference to other devices or services is perceived or identified as harmful.

If you are uncertain of the policy that applies on the use of wireless devices in a specific organization or environment (e.g., airports), you are encouraged to ask for authorization to use the Wireless LAN device prior to turning on the equipment.

Regulatory Information

The Toshiba Wireless LAN Mini PCI Card must be installed and used in strict accordance with the manufacturer's instructions as described in the user documentation that comes with the product. This device complies with the following radio frequency and safety standards.

Canada – Industry Canada (IC)

This device complies with RSS 210 of Industry Canada.

Operation is subject to the following two conditions: (1) this device may not cause interference, and (2) this device must accept any interference, including interference that may cause undesired operation of this device.

L'utilisation de ce dispositif est autorisée seulement aux conditions suivantes: (1) il ne doit pas produire de brouillage et (2) l'utilisation du dispositif doit être prêt à accepter tout brouillage radioélectrique reçu, même si ce brouillage est susceptible de compromettre le fonctionnement du dispositif.

To prevent radio interference to the licensed service, this device is intended to be operated indoors and away from windows to provide maximum shielding. Equipment (or its transmit antenna) that is installed outdoors is subject to licensing.

Pour empêcher que cet appareil cause du brouillage au service faisant l'objet d'une licence, il doit être utilisé à l'intérieur et devrait être placé loin des fenêtres afin de fournir un écran de blindage maximal. Si le matériel (ou son antenne d'émission) est installé à l'extérieur, il doit faire l'objet d'une licence.

USA-Federal Communications Commission (FCC)

This device complies with Part 15 of FCC Rules. Operation of the devices in a Wireless LAN System is subject to the following two conditions:

- ❖ This device may not cause harmful interference.
- ❖ This device must accept any interference that may cause undesired operation.

Caution: Exposure to Radio Frequency Radiation

The radiated output power of the Toshiba Wireless LAN Mini PCI Card is far below the FCC radio frequency exposure limits. Nevertheless, the Toshiba Wireless LAN Mini PCI Card shall be used in such a manner that the potential for human contact during normal operation is minimized. The distance the user needs to be from the antennas, located on top of the LCD, should not be less than 20.0 cm when the display is raised to its normal operating position. Refer to the regulatory statements as identified in the documentation that comes with those products for additional information.

The Toshiba Wireless LAN Mini PCI Card is far below the FCC radio frequency exposure limits.

No other transmitter may be co-located with this device except FCC ID# CJ6PA3121BT.

Refer to the Regulatory Statements as identified in the documentation that comes with those products for additional information.

Nevertheless, it is advised to use the Toshiba Wireless LAN Mini PCI Card in such a manner that human contact during normal operation is minimized.

Interference Statement

This equipment has been tested and found to comply with the limits for a Class B digital device, pursuant to Part 15 of the FCC Rules. These limits are designed to provide reasonable protection against harmful interference in a residential installation. This equipment generates, uses, and can radiate radio frequency energy. If not installed and used in accordance with the instructions, it may cause harmful interference to radio communications. However, there is no guarantee that interference will not occur in a particular installation.

If this equipment does cause harmful interference to radio or television reception, which can be determined by turning the equipment off and on, the user is encouraged to try and correct the interference by one or more of the following measures:

- ❖ Reorient or relocate the receiving antenna.
- ❖ Increase the distance between the equipment and the receiver.
- ❖ Connect the equipment to an outlet on a circuit different from that to which the receiver is connected.
- ❖ Consult the dealer or an experienced radio/TV technician for help.

Toshiba is not responsible for any radio or television interference caused by unauthorized modification of the devices included with this Toshiba Wireless LAN Mini PCI Card, or the substitution or attachment of connecting cables and equipment other than specified by Toshiba.

The correction of interference caused by such unauthorized modification, substitution or attachment will be the responsibility of the user.

Approved Countries for use

This equipment is approved to the radio standard by the countries in Fig. 1.

Australia	Austria	Belgium	Canada	Denmark
Finland	France	Germany	Greece	Iceland
Ireland	Italy	Japan	Luxembourg	Mexico
Netherlands	New Zealand	Norway	Poland	Portugal
Spain	Sweden	Switzerland	UK	USA

Caution: Do not use this equipment except in the countries in Fig. 1.

Caution: Bluetooth and Exposure to Radio Frequency Radiation

The radiated output power of the Bluetooth™ Card from Toshiba is far below FCC radio frequency exposure limits. Nevertheless, the Bluetooth card shall be used in such a manner that the potential for human contact during normal operation is minimized. In order to comply with FCC radio frequency radiation exposure guidelines for an uncontrolled environment, the Bluetooth Card has to be operated with the user maintaining a minimum distance of 20 cm from the antennas located on top of the LCD when the display is raised to its normal operating position. Refer to the Regulatory Statements as identified in the documentation that comes with

those products for additional information. No other transmitter may be co-located with this device except FCC ID# CJ6PA3070WL or CJ6PA3171WL.

CD-ROM, DVD-ROM, DVD-ROM/CD-RW safety instructions

The CD-ROM, DVD-ROM, DVD-ROM/CD-RW drives employ a laser system. To ensure proper use of this product, please read this instruction manual carefully and retain for future reference. Should the unit ever require maintenance, contact an authorized service location.

Use of controls, adjustments or the performance of procedures other than those specified may result in hazardous radiation exposure.

To prevent direct exposure to the laser beam, do not try to open the enclosure.

Location of the required label

(Sample shown below. (Location of the label and manufacturing information may vary.)

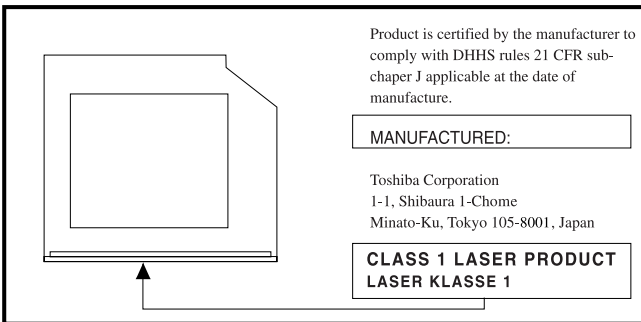

CAUTION: This appliance contains a laser system and is classified as a "CLASS 1 LASER PRODUCT." To use this model properly, read the instruction manual carefully and keep it for your future reference. In case of any trouble with this model, please contact your nearest "AUTHORIZED service station." To prevent direct exposure to the laser beam, do not try to open the enclosure.

CLASS 1 LASER PRODUCT
LASER KLASSE 1

Use of controls or adjustments or performance of procedures other than those specified in the owner's manual may result in hazardous radiation exposure.

Copyright

This guide is copyrighted by Toshiba America Information Systems, Inc. with all rights reserved. Under the copyright laws, this guide cannot be reproduced in any form without the prior written permission of Toshiba. No patent liability is assumed, however, with respect to the use of the information contained herein.

©2002 by Toshiba America Information Systems, Inc. All rights reserved.

Export Administration Regulation

This document contains technical data that may be controlled under the U.S. Export Administration Regulations, and may be subject to the approval of the U.S. Department of Commerce prior to export. Any export, directly or indirectly, in contravention of the U.S. Export Administration Regulations is prohibited.

Notice

The information contained in this manual, including but not limited to any product specifications, is subject to change without notice.

TOSHIBA CORPORATION AND TOSHIBA AMERICA INFORMATION SYSTEMS, INC. (TOSHIBA) PROVIDES NO WARRANTY WITH REGARD TO THIS MANUAL OR ANY OTHER INFORMATION CONTAINED HEREIN AND HEREBY EXPRESSLY DISCLAIMS ANY IMPLIED WARRANTIES OF MERCHANTABILITY OR FITNESS FOR ANY PARTICULAR PURPOSE WITH REGARD TO ANY OF THE FOREGOING. TOSHIBA ASSUMES NO LIABILITY FOR ANY DAMAGES INCURRED DIRECTLY OR INDIRECTLY FROM ANY TECHNICAL OR TYPOGRAPHICAL ERRORS OR OMISSIONS CONTAINED HEREIN OR FOR DISCREPANCIES BETWEEN THE PRODUCT AND THE MANUAL. IN NO EVENT SHALL TOSHIBA BE LIABLE FOR ANY INCIDENTAL, CONSEQUENTIAL, SPECIAL, OR EXEMPLARY DAMAGES, WHETHER BASED ON TORT, CONTRACT OR OTHERWISE, ARISING OUT OF OR IN CONNECTION WITH THIS MANUAL OR ANY OTHER INFORMATION CONTAINED HEREIN OR THE USE THEREOF.

Trademarks

Satellite, Noteworthy, SelectServ, and InTouch are registered trademarks, SecureSleep, and FreedomWare are trademarks of Toshiba America Information Systems, Inc. and/or Toshiba Corporation.

WinDVD is a trademark of InterVideo, Inc.

Microsoft, Windows, DirectX, and DirectShow are registered trademarks, and Media Player is a trademark of Microsoft Corporation.

Dolby is a registered trademark of Dolby Laboratories.

Wi-Fi is a trademark of the Wireless Capability Ethernet Alliance.

TouchPad is a trademark of Synaptics, Inc.

CompuServe is a registered trademark of America Online, Inc.

All other brand and product names are trademarks or registered trademarks of their respective companies.

Computer Disposal Information

This product contains mercury. Disposal of this material may be regulated due to environmental considerations. For disposal, reuse or recycling information, please contact your local government or the Electronic Industries Alliance at www.eiae.org.

Contents

Introduction	23
This guide	23
Safety icons	24
Other icons used	25
Other documentation	25
Service options	26
Chapter 1: Finding Your Way Around	27
Making sure you have everything	27
Front with the display closed	28
Back	28
Right side	30
Left side	31
Front with the display open	32
Keyboard indicator panel	34
System indicator panel	35
CD/DVD control buttons	36
Underside	38

Chapter 2: Getting Started	39
Selecting a place to work	39
Creating a computer-friendly environment.....	39
Keeping yourself comfortable	40
Precautions.....	43
Setting up your computer	45
Setting up your software.....	45
Registering your computer with Toshiba	46
Adding external devices	47
Connecting the AC adapter.....	48
Charging the battery	50
Using the computer for the first time	51
Opening the display panel	51
Turning on the power	51
Using the TouchPad™	53
Primary and secondary control buttons.....	53
Disabling or enabling the TouchPad.....	54
Using the wireless mouse	55
Setting up other devices	57
Installing additional memory (optional)	57
Using an external keyboard.....	61
Connecting a printer	61
Setting up a printer	62
Connecting a USB printer.....	64
Connecting a parallel printer	64
Using external display devices	65
Directing the display output when you	
turn on the computer	65
Adjusting the quality of the external display.....	66
Turning off the computer	67

Caring for your computer.....	68
Cleaning the computer.....	68
Moving the computer.....	68
Using a computer lock.....	69
Chapter 3: Learning the Basics.....	71
Computing tips.....	71
Using the keyboard.....	72
Character keys.....	73
Ctrl, Fn, and Alt keys.....	73
Function keys.....	73
Windows® special keys.....	74
Overlay keys.....	74
Emulating a full-size keyboard.....	76
Using the wireless keyboard.....	76
Removing the keyboard and turning it on.....	76
Installing the keyboard to the computer.....	78
Turning off the keyboard.....	78
Charging the keyboard.....	78
Changing the battery on keyboard.....	78
Starting a program.....	79
Saving your work.....	80
Printing your work.....	81
Using diskettes.....	82
Inserting and removing diskettes.....	82
Caring for diskettes.....	82
Backing up your files.....	83
Copying to a diskette.....	83

Playing a CD or DVD	85
Drive components and control buttons	85
CD/DVD control buttons	87
CD/DVD control and digital audio control	88
Inserting a disc	89
Playing an audio CD	91
Playing a DVD	93
Viewing the contents of a CD or DVD	93
Caring for CDs and DVDs	93
Using the DVD-ROM or DVD-ROM/CD-RW multifunction drive	94
Setting up for communications	94
Connecting the modem	95
Connecting your computer to a network	95
Using the i.LINK® port	96
Powering down the computer	97
Turn Off or Shut down command	97
Hibernation command	98
Standby command	99
Using Turn Off or Shut down	100
Shutting down more quickly	100
Starting again after Turn Off or Shut Down	102
Using Hibernation	102
Using Standby	104
Going into Standby mode more quickly	105
Toshiba's online resources	106

Chapter 4: Mobile Computing	107
Toshiba's energy-saver design	107
Running the computer on battery power	107
Battery Notice	108
Using additional batteries	108
Battery safety precautions.....	108
Charging batteries.....	109
Charging the main battery.....	109
Charging the RTC battery.....	110
Monitoring battery power	111
Determining remaining battery power.....	111
Conserving battery power	112
What to do when the battery runs low	112
Setting battery alarms.....	113
Changing the main battery	114
Removing the battery from the computer	114
Inserting a charged battery	116
Safety precautions	117
Maximizing battery life.....	118
Disposing of used batteries safely	119
Traveling tips.....	120
Chapter 5: Getting to Know the Windows® XP Operating System	121
Lesson 1: Exploring the desktop	122
Finding your way around the desktop	122
Windows® XP file system	124
Lesson 2: Using the TouchPad and control buttons together	125
Lesson 3: Learning about the Internet	128

Lesson 4: Creating a new document	129
Lesson 5: Creating a new folder.....	131
Lesson 6: Starting programs	132
Lesson 7: Resizing, repositioning, and hiding windows	134
Using the taskbar	135
Minimizing and maximizing windows	135
Resizing and moving windows.....	136
Lesson 8: Closing programs	137
Lesson 9: Creating shortcuts	138
Creating a shortcut to the Calculator.....	138
Creating a shortcut to the Character Map	139
Lesson 10: Changing the screen saver.....	141
Lesson 11: Setting the date and time.....	143
Lesson 12: Removing objects from the desktop..	144
Lesson 13: Using System Restore	146
Lesson 14: If I am lost, what do I do?	147
Windows [®] XP Help and Support	147
Using the Windows [®] XP tour	149
Lesson 15: Turning off your computer.....	150
Chapter 6: Exploring Your Options.....	151
Windows [®] XP special features	151
Personalizing your desktop	152
Customizing the taskbar	152
Changing desktop and browsing style	153
Personalizing individual windows	154
Customizing window toolbars	155
Displaying information about each folder.....	156

Using your computer at the office	158
Setting up for communications	158
Connecting the modem to a telephone line	160
Connecting your computer to a network	160
Setting up a wireless connection	161
Accessing the wireless modules using your system tray	161
Setting up a direct cable connection	161
An overview of using the Internet	162
The Internet	162
The World Wide Web	162
Internet Service Providers.....	163
Connecting to the Internet	163
Surfing the Internet.....	164
Internet features.....	164
Uploading and downloading files from the Internet	165
Exploring video features	165
Viewing presentations or DVD movies on your television	165
Playing DVDs	167
Exploring audio features	167
Recording sounds.....	167
Using a microphone.....	168
Adjusting recording quality	169
Using external speakers or headphones.....	169
Using PC Cards	171
PC Card supporting software	171
Inserting PC Cards	172
Removing PC Cards	173
Hot swapping	174

Chapter 7: Toshiba Utilities	175
Power Management	176
Chapter 8: WinDVD	179
Playing DVDs	179
Using the WinDVD toolbar	181
Using the WinDVD status bar	181
Using the WinDVD control panel.....	182
Using the control panel playback buttons	183
Maximizing the video window	185
Using playlists	186
Creating playlists	186
Loading and playing playlists.....	187
Resuming normal playback after using playlists.....	188
Customizing WinDVD.....	188
Setting general properties.....	189
Setting audio properties.....	190
Setting display properties	192
Customizing the control panel	193
Using WinDVD Advanced Features	195
Zooming in.....	200
Panning.....	201
Zooming out	201
Adjusting the color balance.....	201
Launching an Internet browser from WinDVD	202
Getting Help	202
Exiting WinDVD	202

Chapter 9: If Something Goes Wrong	203
Problems that are easy to fix	203
Problems when you turn on the computer	205
The Windows® operating system is not working	206
Using Startup options to fix problems	207
Internet problems	208
The Windows® XP operating system can help you	208
Resolving a hardware conflict	209
A plan of action	209
Resolving hardware conflicts on your own	210
Fixing a problem with Device Manager	211
Memory card problems.....	213
Power and the batteries	213
Keyboard problems.....	215
Display problems	215
Disk drive problems	217
DVD-ROM or DVD-ROM/CD-RW drive problems	219
Secondary IDE Channel DMA setting	222
Sound system problems	228
PC Card problems.....	229
Printer problems	232
Modem problems.....	233
Develop good computing habits	233
If you need further assistance	235
Before you call	235
Contacting Toshiba	235
Other Toshiba Internet Web sites	237
Toshiba's worldwide offices	238

Appendix A: Hot Keys	241
Volume Mute.....	241
Instant password security	242
Without a password	242
With a password	242
Power usage mode	243
Stand By mode	244
Hibernation mode	244
Display modes	245
Display brightness	245
Enabling a wireless device	246
Disabling or enabling the TouchPad	246
Keyboard hot keys	246
Appendix B: Power Cable Connectors.....	247
USA and Canada	247
United Kingdom	247
Australia.....	247
Europe	247
Glossary	249
Index	265

Introduction

Welcome to the world of powerful and portable multimedia computers! With your new Toshiba notebook computer, your access to information can accompany you wherever you go.

You will find that your Microsoft® Windows® XP operating system is already installed on your computer. It offers exciting features and easy Internet access.

This guide

This guide introduces the computer's features. You can:

- ❖ Read the entire guide from beginning to end.
- ❖ Skim through and stop when a topic interests you.
- ❖ Use the table of contents and the index to find specific information.

If you are new to computers, or have not used a notebook computer before, read the first couple of chapters to familiarize yourself with the components of the computer and how to turn it on. After that, seek out whatever interests you most.

Safety icons

This manual contains safety instructions that must be observed in order to avoid potential hazards that could result in personal injuries, damage to your equipment, or loss of data. These safety cautions have been classified according to the seriousness of the risk, and the icons highlight these instructions as follows:



***DANGER:** This icon indicates the existence of a hazard that could result in death or serious bodily injury if the safety instruction is not observed.*



***WARNING:** This icon indicates the existence of a hazard that could result in bodily injury if the safety instruction is not observed.*



***CAUTION:** This icon indicates the existence of a hazard that could result in damage to equipment or property if the safety instruction is not observed.*



***NOTE:** This icon indicates information that relates to the safe operation of the equipment or related items.*

Other icons used

Additional icons highlight other helpful or educational information:



TECHNICAL NOTE: This icon highlights technical information about the computer.



HINT: This icon denotes helpful hints and tips.



DEFINITION: This icon indicates the definition of a term used in the text.

Other documentation

Your computer comes with the following documentation:

- ❖ This electronic version of the user's guide. Look for the user's guide icon on your desktop or in the DOCS folder on the C: drive.
- ❖ Guides for other programs that may come preinstalled on your computer for additional programs on your Recovery CDs.
- ❖ *Toshiba accessories information*, which lists accessories available from Toshiba and explains how to order them.
- ❖ The Microsoft® Windows® operating system documentation which explains the features of the operating system.

Service options

Toshiba offers a full line of service options built around its SelectServ[®] warranty programs. For more information, visit Toshiba's Web site at Toshiba.com.

If you have a problem or need to contact Toshiba, see “[If Something Goes Wrong](#)” on page 203.

Chapter 1

Finding Your Way Around

This chapter presents a “grand tour” of the exterior features of your notebook computer. It serves as a reference when you need to locate parts of the computer.

Making sure you have everything

Before doing anything else, consult the Quick Start card provided with your system to make sure you received everything. If any items are missing or damaged, notify your dealer immediately. For additional help, see [“If you need further assistance” on page 235.](#)

Front with the display closed

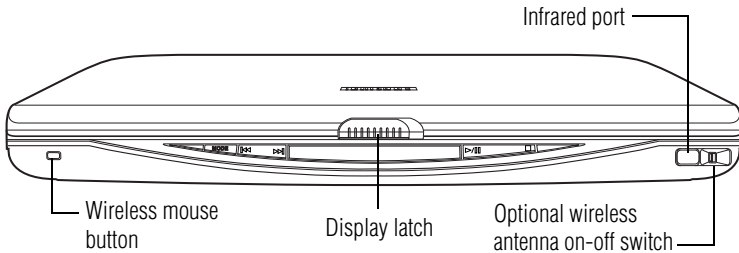

The **wireless mouse** activation button turns on the wireless mouse.

The **display latch** keeps the display panel closed and locked. To open the display panel, slide the display latch to the right and raise the panel.

On those systems with Wi-Fi™, the **wireless antenna on-off switch** turns the computer's wireless antenna on or off.



The **fast infrared port** allows cable-free communication with another device, such as a computer or printer, that has a compatible infrared port.

Back

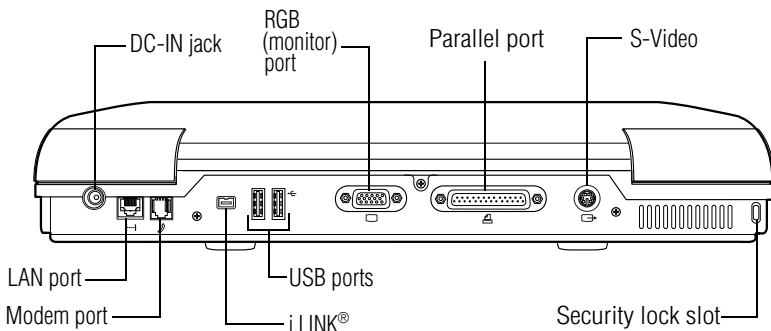

 The **DC-IN jack** is where you plug in the AC adapter.



The **LAN port** enables you to connect the computer to a local area network using a 10/100 Ethernet link.



The **modem port** enables you use a RJ11 telephone cable to connect the modem directly to a standard telephone line. For more information, see [“Connecting the modem” on page 95](#).

i.LINK® port—The i.LINK® port on the back of the computer provides very fast data transfer rates of up to 400 megabits per second (Mbps). You can connect up to 63 external devices to this port.



The **USB (Universal Serial Bus) ports** enables you to connect USB peripherals to your computer.



DEFINITION: USB is a peripheral expansion standard that supports a data-transfer rate of up to 12 Mbps for peripherals such as keyboards, pointing devices, and monitors. USB peripherals have a single standard for cabling and connectors. The USB standard allows hot swapping of peripherals.



The **RGB (monitor) port** enables you to connect an external monitor.



The **parallel port** enables you to connect a parallel printer or other parallel device, including ECP-compatible devices.



S-video enables you to play DVD audio and video on a projector or TV that accepts audio/video inputs.



The **security lock slot** enables you to attach an optional Port Noteworthy® computer lock cable to your computer to secure it to a large, heavy object such as your desk.

Right side

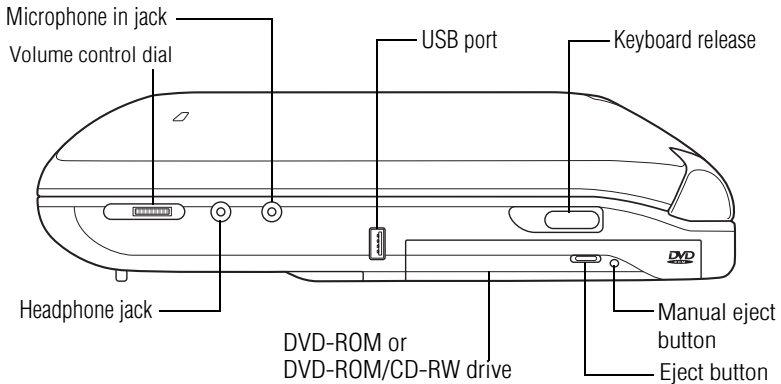

The 3.5 mm **headphone jack** lets you connect stereo headphones or other audio-output devices, such as external speakers. Connecting headphones or other devices to this jack automatically disables the internal speakers.



The 3.5 mm **microphone in jack** lets you connect an external monaural microphone.



The **volume control dial** lets you adjust the loudness of the system speakers.



The **USB (Universal Serial Bus) ports** enables you to connect USB peripherals to your computer.

The **keyboard release** (one on each side) is used to remove the wireless keyboard.

The **DVD-ROM** or **DVD-ROM/CD-RW drive** enables you to play high-resolution, full-screen videos at up to 30 frames per second. You can also use it to install and run programs from application CD-ROMs and play audio CDs.

The **eject button** opens the drive tray.

The **manual eject button** enables you to open the drive tray when the computer is off.



CAUTION: Never use a pencil to press the manual eject button. Pencil lead can break off inside the computer and damage it. Instead, use a slim object such as a straightened paper clip.

Left side

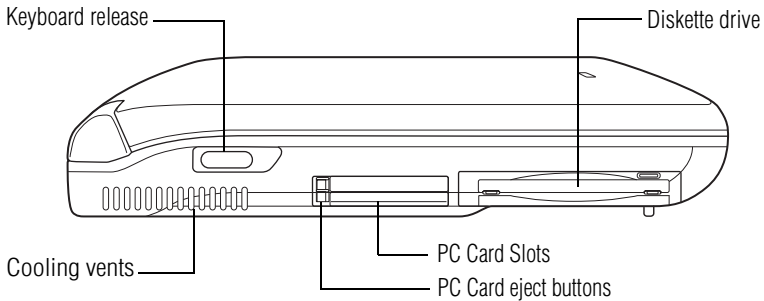

The **keyboard release** (one on each side) is used to remove the wireless keyboard.

The **cooling vents** prevent the computer's central processing unit (CPU) from overheating so that it can continue to perform at its maximum speed.



CAUTION: To prevent possible overheating of the CPU, make sure you do not block the cooling vents.

The **diskette drive** allows you to use either high-density or double-density 3.5-inch diskettes.



The two stacked **PC Card slots** support up to two Type II PC Cards, or one Type III PC Card. See [“Using PC Cards” on page 171](#) for more information.

The **PC Card eject buttons** release PC Cards from the corresponding slots.

Front with the display open

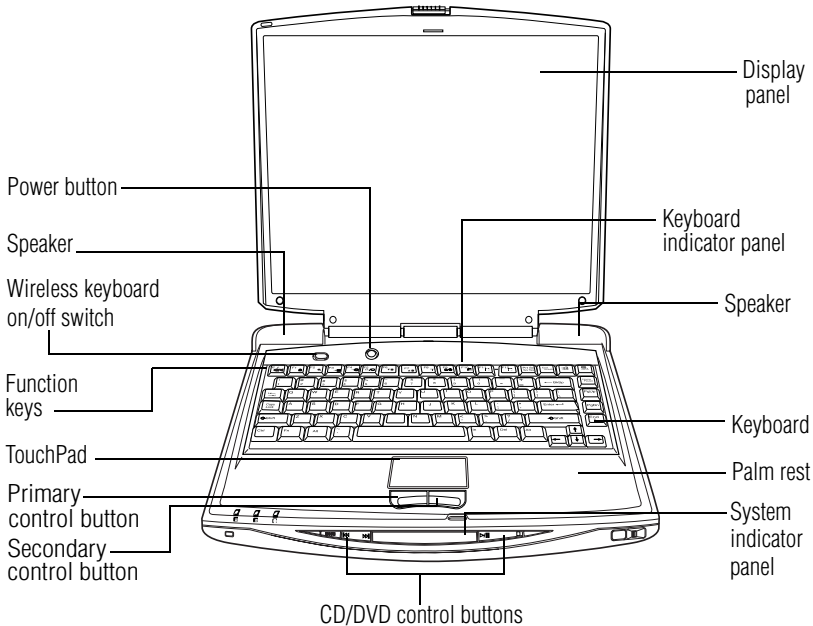

The **power button** turns the computer on and off.

The **stereo speakers** let you hear sounds, such as system alarms associated with your software, and music from DVD-ROMs and audio CDs.

The **wireless keyboard on/off switch** is used for turning the power on and off for the wireless keyboard when it is removed from the computer.

The **function keys**, when used with the Fn key, activate several different system functions. For more information, see [“Hot Keys” on page 241](#).

The **TouchPad™** enables you to move the cursor with the stroke of a finger.

The **Primary control button** next to the TouchPad acts like the primary button on a mouse.

The **Secondary control button** next to the TouchPad acts like the secondary button on a mouse.

For more information on Primary and Secondary control buttons, see [“Using the TouchPad™” on page 53](#).

The CD/DVD control buttons allow you to play audio CDs when the computer is turned off. You can also use them to play CDs and DVDs with the computer turned on. For a description of these controls, see [“CD/DVD control buttons” on page 36](#).

The lights on the **system indicator panel** provide information about system functions. For a description of these lights, see [“System indicator panel” on page 35](#).

The computer’s **screen** is a liquid crystal display (LCD) that provides clear, sharp images. For more information on your viewing options, see [“Display modes” on page 245](#).

The lights on the **keyboard indicator panel** provide information about keyboard functions. For details, see [“Keyboard indicator panel” on page 34](#).

The 85-key **keyboard** provides all the functionality of a full-size keyboard. For more information, see [“Using the keyboard” on page 72](#).

The front panel provides a **palm rest** to assist you in maintaining proper posture while using the computer.

Keyboard indicator panel

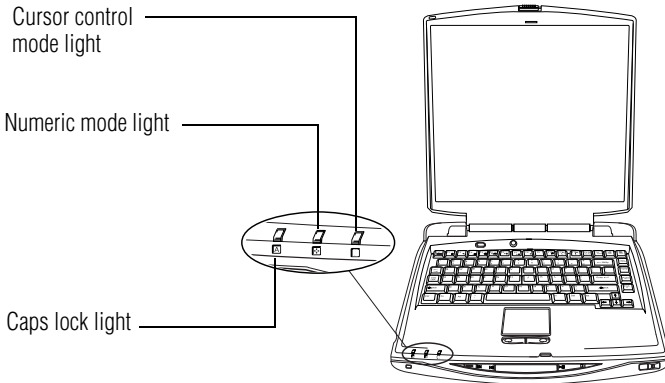

The **cursor control mode light** glows when the cursor control overlay is on. When this light is on, pressing an overlay key moves the cursor in the direction of the arrow printed on the front of the key instead of typing the letter printed on the top of the key. For more information, see “[Overlay keys](#)” on page 74.



The **numeric mode light** glows when the numeric overlay is on. When this light is on, pressing an overlay key types the number printed on the front of the key instead of typing the letter printed on the top of the key.



Caps lock light—The light on the Caps lock key glows when the Caps lock is on.

System indicator panel

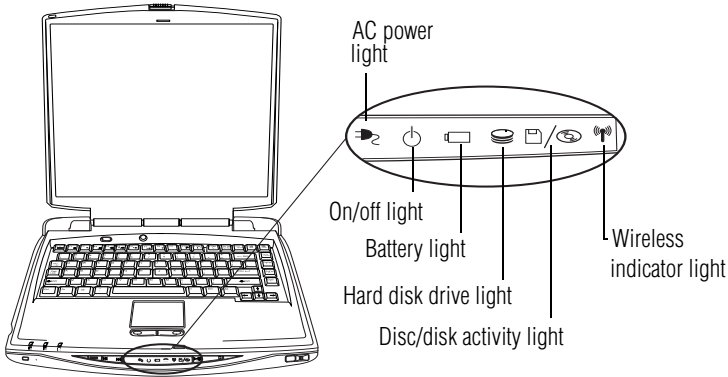

The system indicator lights are under a tinted panel and are visible only when the feature they represent is either on, or both on and active.



The **AC power light** glows green when the computer is connected to an external power source.



The **on/off light** glows green when the computer is on. The light glows amber when the computer is in Standby mode.



The **battery light** indicates the main battery's current charge. It glows green steadily when the battery is fully charged. It glows amber while the battery is being charged. It does not glow if the external power source is disconnected or if the battery is completely discharged. For more information on determining remaining battery power, see [“Monitoring battery power”](#) on page 111.



The **hard disk drive light** flashes green while the hard disk drive is being accessed.



Wireless indicator light—Flashes to indicate that wireless device is currently in use.



The **disc/disk activity light** flashes green when the diskette drive, the DVD-ROM or the DVD-ROM/CD-RW drive is being accessed.



CAUTION: Never turn off the computer while any drive is in use. Doing so could damage the media in use and result in loss of data.

CD/DVD control buttons

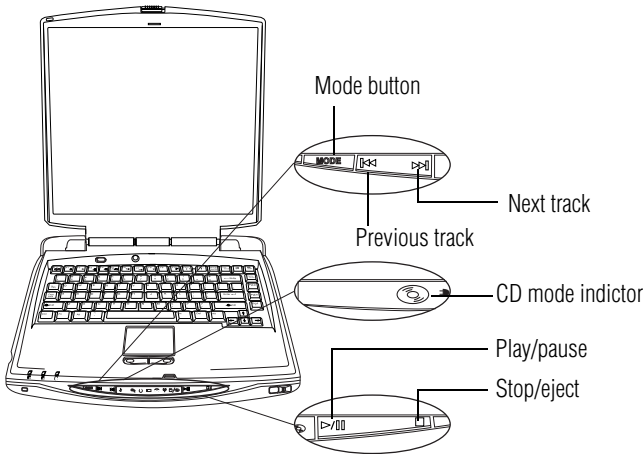

The control buttons near the display latch are for playing CDs and DVDs. You can play audio CDs while the computer is turned off.



CD/DVD control buttons with CD/DVD mode indicator shown

The **mode** button enables you to toggle between two modes: digital mode, signified by musical notes graphic on the indicator panel; and CD/DVD mode, signified by a CD disc graphic on the indicator panel.

Press and hold the mode button for a few seconds, until the CD mode indicator lights to show that the CD control buttons on the front panel are now functional.

-  The **previous track** button returns the disc player to the preceding track on the disc.
-  The **next track** button causes the disc player to skip to the following track on the disc.



NOTE: If you have set a password for logging onto your system, your computer starts up and you need to log on before being able to play a CD or DVD.

-  The **play/pause** button begins play, or pauses the disc player if it is currently playing.
 - The **stop/eject** button stops a disc that is currently playing. To eject the disc press the button again.
- Pressing the mode button once more places the computer in digital mode.

Underside

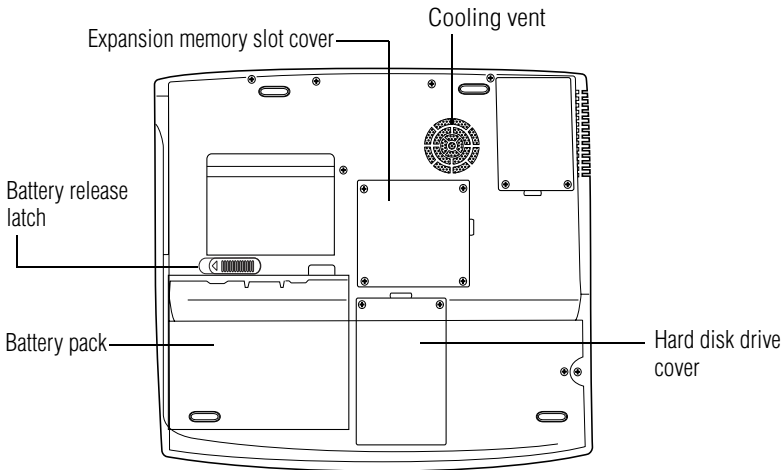

The **expansion memory cover** protects the slots where you insert additional memory. See “[Installing additional memory \(optional\)](#)” on page 57 for detailed information.

The **cooling vent** helps keep your computer at an optimum temperature.



CAUTION: To prevent possible overheating of the CPU, make sure you do not block the cooling vents.



The **battery pack** lets you use your computer when a standard electrical outlet is not available. For information about replacing the battery, see “[Changing the main battery](#)” on page 114.



The **battery release latch** secures the battery pack to the computer, preventing the pack from dislodging from the computer case.

The **hard disk drive cover** protects the computer’s hard disk drive.

Chapter 2

Getting Started

This chapter provides tips for working comfortably, describes how to connect components, and explains what to do the first time you use your notebook computer.

Selecting a place to work

Your computer is portable and designed to be used in a variety of circumstances and locations.

Creating a computer-friendly environment

Place the computer on a flat surface that is large enough for the computer and any other items you need to use, such as a printer. Leave enough space around the computer and other equipment to provide adequate ventilation and prevent overheating.

To keep your computer in prime operating condition, protect your work area from:

- ❖ Dust, moisture, and direct sunlight

-
- ❖ Equipment that generates a strong electromagnetic field, such as stereo speakers (other than speakers that are connected to the computer) or speakerphones
 - ❖ Rapid changes in temperature or humidity and sources of temperature change, such as air conditioner vents or heaters
 - ❖ Extreme heat, cold, or humidity
 - ❖ Liquids and corrosive chemicals
-



CAUTION: If you spill liquid into the computer, turn it off, unplug it from the AC power source, and let it dry out completely before turning it on again.

If the computer does not operate correctly after you turn it back on, contact a Toshiba authorized service provider.

Keeping yourself comfortable

Strain and stress injuries are becoming more common as people spend more time using their computers. With a little care and proper use of the equipment, you can work comfortably throughout the day.

This section provides hints on avoiding strain and stress injuries. For more information, consult books on ergonomics, repetitive-strain injury, and repetitive-stress syndrome.

Placement of the computer

Proper placement of the computer and external devices is important to avoid stress-related injuries.

- ❖ Place the computer on a flat surface at a comfortable height and distance. You should be able to type without twisting your torso or neck, and look at the screen without slouching.

- ❖ If you are using an external monitor, the top of the display should be no higher than eye level.
- ❖ If you use a paper holder, set it at about the same height and distance as the screen.

Seating and posture

When using your computer, maintain good posture with your body relaxed and your weight distributed evenly. Proper seating is a primary factor in reducing work strain. Some people find a backless chair more comfortable than a conventional chair.

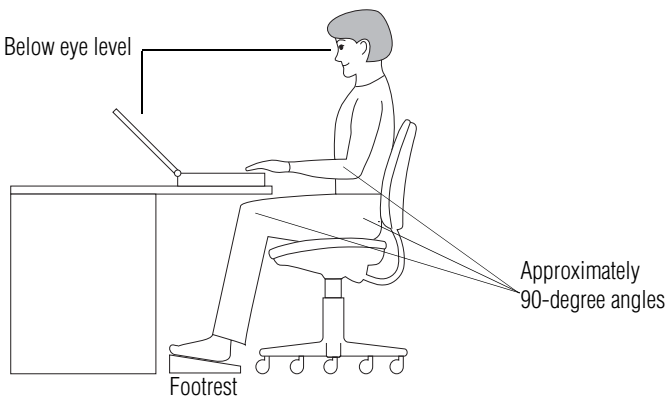

Correct posture and positioning of the computer

Whichever type you choose, use the following guidelines to adjust your chair for maximum computing comfort.

- ❖ Position your chair so that the keyboard is at or slightly below the level of your elbow. You should be able to type comfortably with your shoulders relaxed and your forearms parallel to the floor.

If you are using a conventional chair:

- ❖ Your knees should be slightly higher than your hips. If necessary, use a footrest to raise the level of your knees and ease the pressure on the back of your thighs.

- ❖ Adjust the back of your chair so that it supports the lower curve of your spine. If necessary, use a cushion to provide extra back support. Lower-back-support cushions are available at many office supply stores.
- ❖ Sit with your back straight so that your knees, hips, and elbows form approximately 90-degree angles when you work. Do not slump forward or lean back too far.

Lighting

Proper lighting can improve the visibility of the display and reduce eyestrain.

- ❖ Position the display panel or external monitor so that sunlight or bright indoor lighting does not reflect off the screen. Use tinted windows or shades to reduce glare.
- ❖ Avoid placing your computer in front of a bright light that could shine directly in your eyes.
- ❖ If possible, use soft, indirect lighting in your computer work area.

Arms and wrists

- ❖ Avoid bending, arching, or twisting your wrists. Keep them in a relaxed, neutral position while typing.
- ❖ Exercise your hands, wrists, and arms to improve circulation.



***WARNING:** Using the computer keyboard incorrectly may result in discomfort and possible injury. If your hands, wrists, and/or arms bother you while typing, stop using the computer and rest. If the discomfort persists, consult a physician.*

Work habits

The key to avoiding discomfort or injury from strain is to vary your activities. If possible, schedule a variety of tasks into your working day. Finding ways to break up the routine can reduce stress and improve your efficiency.

- ❖ Take frequent breaks to change position, stretch your muscles, and relieve your eyes. A break of two or three minutes every half-hour is more effective than a long break after several hours.
- ❖ Avoid performing repetitive activities for long periods. Intersperse such activities with other tasks.
- ❖ Focusing your eyes on your computer screen for long periods can cause eyestrain. Look away from the computer frequently and focus your eyes on a distant object for at least 30 seconds.

Precautions

Your notebook computer is designed to provide optimum safety and ease of use, and to withstand the rigors of travel. You should observe certain precautions to further reduce the risk of personal injury or damage to the computer.

- ❖ Avoid prolonged physical contact with the underside of the computer.

If the computer is used for long periods, its case can become very warm. While the temperature may not feel too hot to the touch, if you maintain physical contact with the computer for a long time (if you rest the computer on your lap, for example), your skin might suffer low-heat injury.

- ❖ Never apply heavy pressure to the computer or subject it to sharp impacts. Excessive pressure or impact can damage computer components or otherwise cause your computer to malfunction.

- ❖ Some PC Cards can become hot with prolonged use. If two cards are installed, both can become hot even if only one is being used. Overheating of a PC Card can result in errors or instability in its operation.

Be careful when you remove a PC Card that has been used for a long period.

- ❖ Avoid spilling liquids into the computer's keyboard.

If you do spill a liquid that gets into the keyboard, turn off the computer immediately, disconnect the AC power adapter, and remove the battery. Leave the computer turned off overnight to let the keyboard dry out before you use it again.

- ❖ Never turn off the computer if a drive-in-use light indicates a drive is active.

Turning off the computer while it is reading from or writing to a disk can damage the disk, the drive, or both.

- ❖ Keep the computer and disks away from objects that generate strong magnetic fields, such as large stereo speakers.

Information on disks is stored magnetically. Placing a magnet too close to a disk can erase important files.

- ❖ Scan all new files for viruses.

This precaution is especially important for files you receive via diskette, email, or download from the Internet. Occasionally, even new programs you buy from a supplier may contain a computer virus. You'll need a special program to check for viruses. Ask your dealer to help you.

Setting up your computer

Your computer contains a rechargeable high-capacity battery that needs to be charged before you can use it.

To use external power or to charge the battery, attach the AC adapter. See “[Connecting the AC adapter](#)” on page 48.

Setting up your software

The first time you turn on your computer, the Setup Wizard guides you through steps to set up your software.

- 1 From the welcome screen, click **Next** to enter the Setup Wizard.
- 2 Confirm acceptance of Microsoft’s End User License Agreement and click **Next**.
- 3 Enter the computer name and description and click **Next** or **Skip**.

The computer will pause for a moment while checking for an internet connection.

A window will display the message: “An Internet connection could not be chosen.”

- 4 Click **Skip** to exit the process or **Next** to continue.



NOTE: To register online, your computer’s modem must be connected to a voice-grade telephone line.

A window will display asking if you wish to register with Toshiba and Microsoft.

- 5 Click **Yes** to register, or **No** to exit the process.
-



NOTE: If you click No, you may register with Toshiba by clicking the Register with Toshiba icon on the desktop.

- 6 Enter your personal information in the registration window.
- 7 Enter your name and click **Finish** to complete the process.

Your computer restarts automatically.

Registering your computer with Toshiba

Registering your computer lets Toshiba keep you up-to-date with information about new products and upgrades, and also extends your Toshiba warranty worldwide at no charge to you. You can register your computer with Toshiba by double-clicking the icon on your desktop or by mailing the registration card that may ship with your computer.



NOTE: To register online, your computer's modem must be connected to a voice-grade telephone line.

Completing installation

Upon completion, you will be prompted to click **Finish** to restart your computer.

Adding external devices



NOTE: Before adding external devices, Toshiba recommends setting up your software first. See “Setting up your software” on page 45.

Before starting to use your computer, you may also want to:

- ❖ Add more memory (see “Installing additional memory (optional)” on page 57)
- ❖ Connect a full-size keyboard (see “Using an external keyboard” on page 61)
- ❖ Connect an external monitor (see “Using external display devices” on page 65)
- ❖ Connect a local printer (see “Connecting a printer” on page 61)
- ❖ Install PC Cards (see “Using PC Cards” on page 171)

Connecting the AC adapter

The AC adapter enables you to power the computer from an AC outlet and to charge the computer's batteries. The AC power light on the computer glows when the device is plugged in.

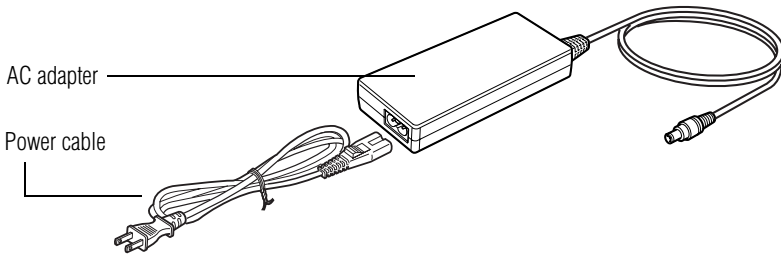

Power cable and AC adapter

To connect AC power to the computer:

- 1** Connect the power cable to the AC adapter.

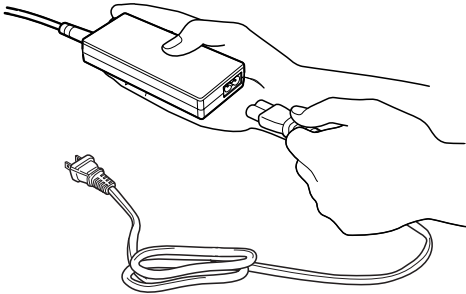

Connecting the power cable to the AC adapter



- 2** Plug the AC adapter into the DC-IN jack on the back of the computer.

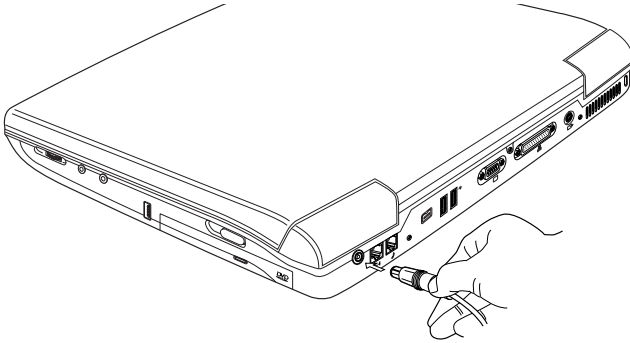

Connecting the adapter to the computer

- 3 Connect the power cable to a live electrical outlet.
The AC power and battery lights glow.



DANGER: Damaged power cables can cause fire or electric shock. Never modify, forcibly bend, place heavy objects on top of, or apply heat to the power cable.

If the power cable becomes damaged or the plug overheats, discontinue use. There is a risk of electric shock.

Never remove the power plug from the outlet with wet hands. Doing so can cause an electric shock.



CAUTION: Using the wrong AC adapter could damage your computer. Toshiba assumes no liability for any damage in such cases.

Never pull directly on the power cable to unplug it. Hold the power plug when removing the cable from the outlet.

Charging the battery

Before you can use the battery to power the computer, you must charge it. Connect the computer to a live power outlet using the AC adapter and power cable. The on/off light glows green and the battery light glows amber to show that it is charging.

Once the computer is connected to a power outlet, you can charge the battery with the computer turned off or on. It takes several hours to charge the battery when the computer is off. It takes much longer to charge the battery when the computer is on. If the computer is not consuming full power, the time required to charge the battery is reduced.

For more information on battery use, see [“Running the computer on battery power”](#) on page 107.



CAUTION: Once the battery is charged for the first time, avoid leaving the computer plugged in and turned off for more than a few hours at a time. Continuing to charge a fully charged battery can damage the battery.

Using the computer for the first time

Opening the display panel

Slide the display latch to the right and lift the display panel.

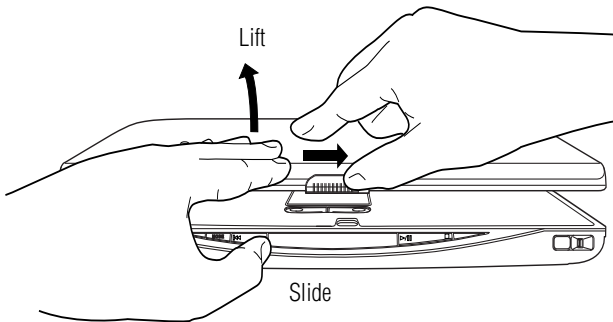

Opening the display panel



CAUTION: To avoid damaging the display panel, don't force it beyond the point where it moves easily.

Never lift or move the computer using the display panel.

Turning on the power

- 1 Check that all the drives are empty.
- 2 If you have a printer connected to your computer, turn on the printer and wait until the printer indicates that it is ready (on line).
- 3 Turn on the computer by pressing the power button located above the keyboard.



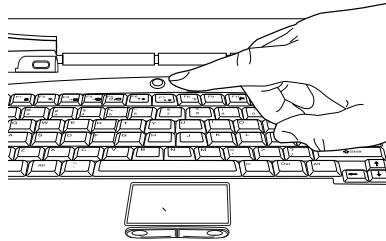

Pressing the power button



NOTE: When you turn on the computer for the first time, don't turn off the power again until the operating system has loaded completely.



The AC power light glows when the computer is connected to an external power source.



The battery light:

- ❖ Glows amber while the battery is being charged.
- ❖ Glows green when the battery is fully charged.
- ❖ Is not lit when the computer is not connected to an external power source. For information on determining battery power, see [“Monitoring battery power” on page 111](#).



The hard disk drive light flashes to indicate that the hard disk drive is currently in use.



CAUTION: Never turn off the computer while any drive is in use.

Using the TouchPad™

The TouchPad, the small, smooth square cutout located in front of the keyboard, is sensitive to touch and enables you to move the cursor with the stroke of a finger. Simply move your finger on the TouchPad in the direction you'd like to move the cursor:

- ❖ To move the cursor to the top of the page, push your finger forward on the TouchPad.
- ❖ To move the cursor to the bottom of the page, drag your finger toward yourself.
- ❖ To move the cursor to the right side of the page, slide your finger across the TouchPad from left to right.
- ❖ To move it to the left side, slide your finger from right to left.



NOTE: Because the TouchPad is much smaller than the display screen, moving your cursor across the screen often means having to move your finger several times across the TouchPad in the preferred direction.

Once you've positioned your cursor, you can either click it into place by double-tapping the TouchPad or clicking the control buttons. For more on the TouchPad, see [“Lesson 2: Using the TouchPad and control buttons together”](#) on page 125.

Primary and secondary control buttons

When you want to click or choose an item, use the TouchPad to move the pointer/cursor to the item. Once the pointer/cursor is positioned, you can click it into place by either double-tapping the TouchPad or clicking the control buttons.

The control buttons are adjacent to the TouchPad and are used like the buttons on a mouse. The primary control button is the

left one and corresponds to the left mouse button. To double-click, press the primary button twice in rapid succession.

The function of the secondary button depends on the program you are using. It usually corresponds to the right mouse button. Check your program's documentation to find whether it uses the secondary mouse button.

Disabling or enabling the TouchPad

The TouchPad is enabled by default. To change the enable/disable TouchPad setting:

- 1 Click **Start, Control Panel**.

The Control Panel window appears.

- 2 Click **Printers and Other Hardware**.

- 3 Click **Mouse Properties**.

The Mouse Properties window appears.

- 4 Click the **TouchPAD ON/OFF** tab.

The TouchPAD ON/OFF tab view window appears.

- 5 Select **Disable** or **Enable**, whichever is appropriate.

- 6 Click **Apply**.

- 7 Click **OK**.

The Mouse Properties window closes.

- 8 Close the Printers and Other Hardware window.

- 9 Close the Control Panel window.

You can also use a hot key to disable or enable the TouchPad.

Using the wireless mouse

The wireless mouse, combined with the wireless keyboard, gives you extra mobility when using your computer. You can move the mouse and keyboard several feet from your system. This allows you to perform normal mouse and keyboard functions without the restrictions of a wired mouse and keyboard. These features can make you more comfortable when using your computer.

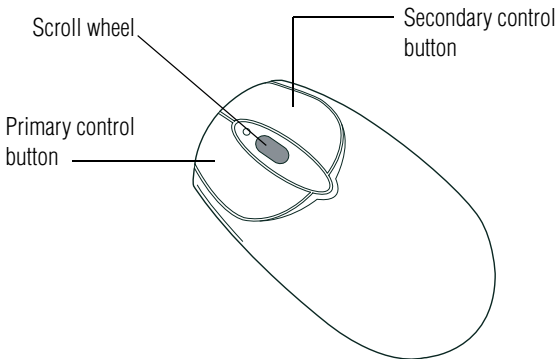

Wireless mouse

Installing batteries in the wireless mouse

The mouse requires two AA batteries. To insert the batteries, turn the mouse over and remove the battery cover. Insert the batteries and replace the battery cover.

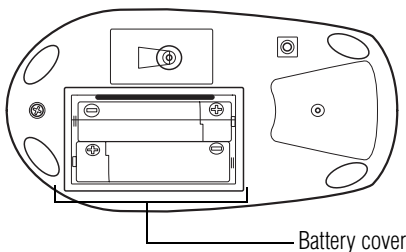

Wireless mouse battery location

Activating the mouse

When you turn your computer on, the wireless mouse turns on automatically. If the mouse does not turn on, press the left button on the front of your computer.

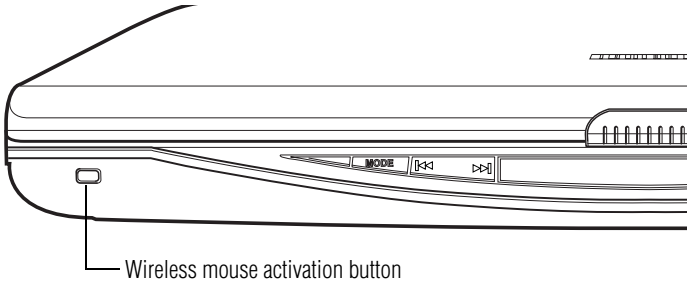

Wireless mouse activation button

If the above method does not turn on the mouse, press the reset button on the bottom of the mouse.

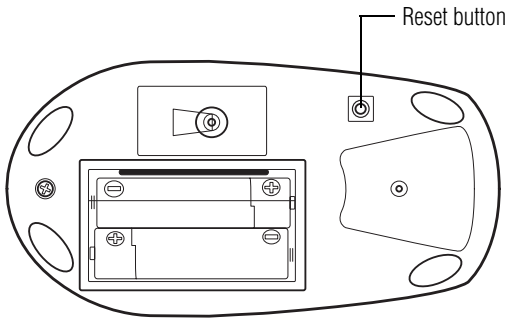

Wireless mouse reset button

Once the wireless mouse is activated, it operates much the same as a standard mouse.

Setting up other devices

Installing additional memory (optional)

Your computer comes with enough memory to run most of today's popular applications. You may want to increase the computer's memory if you use complex software or process large amounts of data.

Your computer is equipped with two memory slots, which are available for you to add additional memory modules of either 128, 256, and 512 MB capacity.

You need a standard Phillips no. 1 screwdriver to install a memory module.



CAUTION: To avoid damaging the computer's screws, use a standard Phillips no. 1 screwdriver that is in good condition.

If the computer is on, begin at step 1; otherwise, skip to step 4.

- 1** If the computer is on, click **Start, Turn Off Computer**.
The Turn off computer window appears.
- 2** Click **Turn Off**.
The operating system turns off the computer.
- 3** Unplug and remove any cables connected to the computer.
- 4** Remove the battery. For steps on removing the battery, see [“Changing the main battery”](#) on page 114.

- 5 Close the display panel and turn the computer upside down to locate the expansion memory slot cover to the empty memory slots.

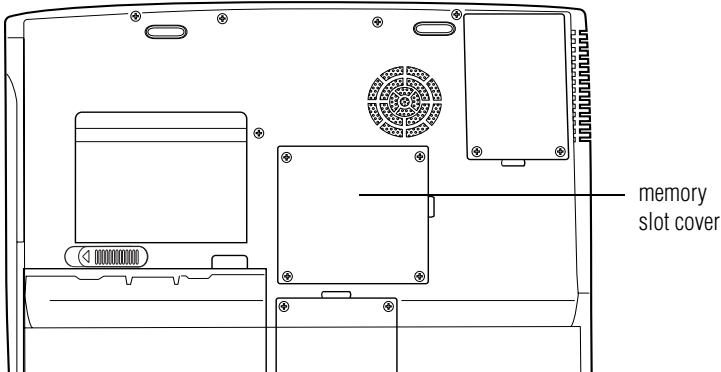

Base of the computer

- 6 Using a standard Phillips no. 1 screwdriver, unscrew the four screws that secure the memory slot cover, and then remove the memory slot cover.

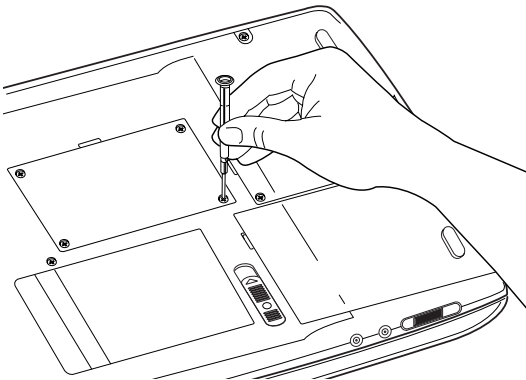

Removing the memory slot cover screws

- 7 Put the screws and the cover in a safe place so that you can retrieve them later.



CAUTION: Static electricity can damage the memory module. Before you handle the module, touch a grounded metal surface to discharge any static electricity you may have built up.

To avoid damaging the memory module, be careful not to touch its gold connector bar (on the side you insert into the computer).

- 8** Remove the new memory module from its antistatic packaging.
- 9** Holding the memory module by its edges so that the gold connector bar faces the slot, fit the module into the socket.
- 10** Gently press down on the memory module connector until the clips snap into place.

Do not force the module into position. The memory module should be level when secured in place.

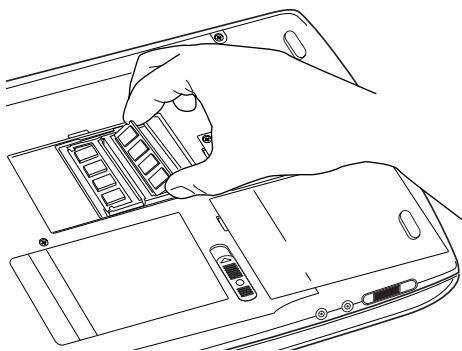

Inserting the memory module



CAUTION: Avoid touching the connectors on the memory module or on the computer. Grease or dust on the connectors may cause memory access problems.

- 11 Replace the memory slot cover.
- 12 Replace the screws and tighten them.
- 13 Replace the battery.
- 14 Turn the computer over and reconnect any cables you removed.
- 15 To verify that the computer correctly recognizes the memory:
 - ❖ Click **Start**, then click **Control Panel**.
 - ❖ Click the **Performance and Maintenance** icon.
 - ❖ Click **System**.
 - ❖ The **General** tab view automatically appears and shows the recognized memory.
- 16 If the computer does not recognize the memory, turn off the computer, remove the memory slot cover, and make sure the memory module is seated properly, as described in [step 10](#).

Removing a memory module

- 1 Follow steps 1 through 6 in “[Installing additional memory \(optional\)](#)” on page 57.
- 2 Gently push the memory locks outward until the memory module pops up.
- 3 Gently pull the memory module diagonally out of the slot.
- 4 Complete the procedure by following steps [11](#) through [15](#).

Using an external keyboard

If you prefer to use a full-size keyboard, you can attach one to your computer provided that the keyboard is USB-compatible.

To connect a keyboard, attach its cable to one of the computer's USB ports.

Connecting a printer



NOTE: Read the documentation that came with your printer. Follow the manufacturer's instructions when connecting a local printer.



NOTE: You must supply the proper printer cable. If one did not come with your printer, you may purchase one from an electronics or computer store.

If your printer is ECP- or IEEE-compliant, make sure your printer cable is an IEEE 1284 cable.



CAUTION: Your printer documentation may require you to install the printer software before physically connecting the printer to your computer. If you do not install the software as instructed by the printer manufacturer, the printer may not function correctly.



CAUTION: Never connect the printer cable while the computer's power is on. Doing so may damage the printer, the computer, or both.

You can connect a USB-compatible printer to your computer through the USB ports. To determine if the printer is USB-compatible, check its documentation.

To achieve the connection, you need a suitable USB cable, which may come with your printer. You can purchase one from a computer or electronics store.

To connect a printer:



- 1 Connect the USB cable to the USB port.
- 2 Connect the printer's power cable to a wall outlet.
- 3 Turn on the printer.

Setting up a printer

If you started your computer with a printer connected and turned on, it may have been detected automatically. If this is not the case, then you must install the printer driver for the model of printer that is connected to your computer. You install the printer driver either by following the instructions indicated in your printer manual, or by using the operating system's Add Printer Wizard.

If you plan to set up a printer later, click **Cancel**.

Using the Add Printer Wizard

To set up a printer with the Add Printer Wizard:

- 1 Click **Start, Control Panel**.
- 2 Click **Printers and Other Hardware**.
- 3 Click **Printers and Faxes**.

The Printers and Faxes window appears.

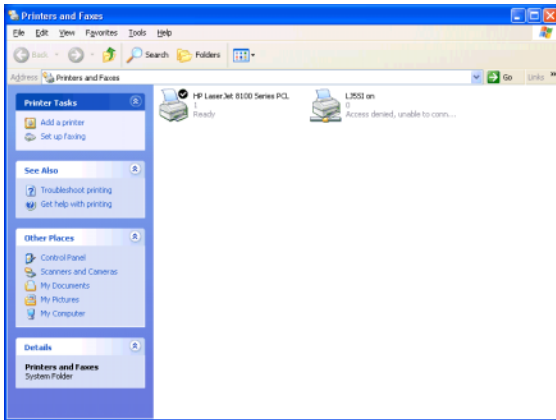

Sample Printers and Faxes window

4 Click Add a Printer.

The Add Printer Wizard window appears.

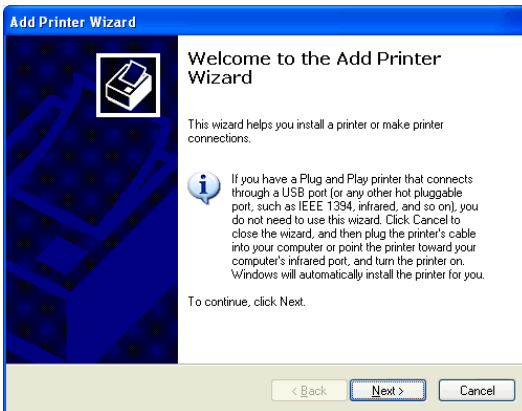

Sample Add Printer Wizard

-
- 5** Follow the instructions.
-



HINT: If you are using more than one printer, make sure the printer name is descriptive enough to help you tell the difference between other printers.

Connecting a USB printer

To achieve the connection, you need a suitable USB cable, which may come with your printer. Otherwise, you can purchase one from a computer or electronics store.



NOTE: Follow the manufacturer's instructions for connecting a USB printer to your computer.

Connecting a parallel printer

To achieve the connection, you need a suitable cable, which may come with your printer. Otherwise, you can purchase one from a computer or electronics store.



NOTE: Follow the manufacturer's instructions for connecting a parallel printer to your computer.

Using external display devices

Your computer comes with a built-in LCD display, but you can easily attach an external monitor to your computer if you need a larger screen. To do this:



- 1 Turn off the computer.
- 2 Connect the monitor's video cable to the RGB (monitor) port on the rear of the computer.
- 3 Connect the monitor's power cable to a live electrical outlet.
- 4 Turn on the external monitor.
- 5 Turn on the computer.
- 6 Set the display mode by pressing Fn + F5, or by setting the Display Properties settings.

Directing the display output when you turn on the computer

Once you've connected an external display device, you can choose to use the internal display only, the external device only, or both simultaneously. The quickest way to change the display output settings is to use the display hot key (Fn + F5).

- 1 While holding down Fn, press F5 repeatedly until the setting you want takes effect.

This hot key cycles through the settings in the following order:

- ❖ Built-in display panel only
- ❖ Built-in display panel and external monitor simultaneously
- ❖ External monitor only
- ❖ Built-in display panel and external video device simultaneously
- ❖ Other external video device only

-
- 2 Release the Fn key.
-



NOTE: You can also change these settings using the Display Properties box in the Control Panel.

Adjusting the quality of the external display

To obtain the best picture quality from your external display device, you may need to adjust the video settings. See the documentation supplied with the device for additional configuration steps.



TECHNICAL NOTE: In order to use the simultaneous mode, you must set the resolution of the internal display panel to match the resolution of the external display device. The external display device must support a resolution of 640 X 480 or higher.

Display limitations

The quality of the display is limited to the capabilities of the external video device.

- ❖ If the external video device, such as an SVGA monitor, is capable of displaying at a maximum resolution of 640 x 480 and your system is set for a higher resolution, only part of the desktop will appear on the screen. You can view the “lost” area by scrolling to it.
- ❖ If you use the display hot key (Fn + F5) to change the display output with the **LCD Display Stretch** option enabled and the Display area (resolution) set to 640 x 480 or 800 x 600, the image on the internal display panel may appear stretched.

Turning off the computer

It is a good idea to turn off your computer when you are not using it for a while.

If you are using the computer for the first time, leave the computer plugged into a power source (even though the computer is off) to fully charge the main battery. With the computer off, it may take several hours to recharge the main battery.

Guidelines for turning off the computer:

- ❖ To leave the computer off for a longer period, use the Windows® Turn Off command. Alternatively, use Hibernation mode to save the system settings to the hard disk.
- ❖ If you have work in progress and are not connected to a network, use the operating system Standby command to save your system settings to memory so that, when you turn on the computer again, you automatically return to where you left off.
- ❖ Never turn off the power while a drive-in-use light on the system indicator panel is on. Doing so may damage your hard disk, diskette drive, DVD-ROM or DVD-ROM/CD-RW drive.

For more information, see [“Powering down the computer” on page 97](#).

Caring for your computer

This section gives tips on cleaning and moving your computer, and explains how to fit an antitheft lock. For information about taking care of your computer's battery, see [“Running the computer on battery power” on page 107](#).

Cleaning the computer

To keep your computer clean, gently wipe the display panel and exterior case with a lightly dampened cloth. Ask your Toshiba dealer for suggestions for appropriate cleaning products.



CAUTION: Keep liquid, including cleaning fluid, out of the computer's keyboard, speaker grille, and other openings. Never spray cleaner directly onto the computer. Never use harsh or caustic chemical products to clean the computer.

Moving the computer

Before moving your computer, even across the room, make sure all disk activity has ended (the drive-in-use lights stop glowing) and all external peripheral cables are disconnected.



CAUTION: Never pick up the computer by its display panel or by the back (where the ports are located).

Although your notebook computer is built to withstand reasonable shock and vibration, transport it in a carrying case for long trips. You can purchase a carrying case from your Toshiba dealer or through Toshiba's Web site at toshibaaccessories.com.

Using a computer lock

You may want to secure your computer to a heavy object such as your desk. The easiest way to do this is to purchase an optional Port Noteworthy® computer lock cable.



Port Noteworthy® computer lock cable

To secure the computer:

- 1** Loop the cable through or around some part of a heavy object.

Make sure there is no way for a potential thief to slip the cable off the object.

- 2** Pass the locking end through the loop.

-
-  **3** Insert the cable's locking end into the security lock slot located on the right side of the computer, then rotate the key a quarter turn and remove it.

The computer is now securely locked to deter theft.

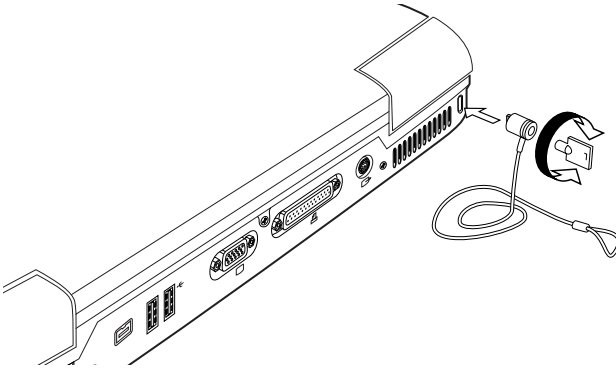

Locking the computer

Chapter 3

Learning the Basics

This chapter lists some computing tips and provides important information about basic features.

Computing tips

- ❖ Save your work frequently.

Your work stays in the computer's temporary memory until you save it to the disk. You will lose all unsaved work, if, for example, a system error occurs and you must restart your computer, or your battery runs out of charge while you are working. Your computer can be configured to warn you when the battery is running low. See [“Setting battery alarms”](#) on page 113.



HINT: Some programs have an automatic save feature that you can turn on. This feature saves your file to the hard disk at preset intervals. See your software documentation for details.

- ❖ Back up your files to diskettes (or other removable storage media) on a regular basis. Label the backup copies clearly and store them in a safe place.

If your hard disk suddenly fails, you may lose all the data on it unless you have a separate backup copy.

- ❖ Use Disk Defragmenter to conserve disk space and help your computer perform at its optimal level.
- ❖ Before turning off the computer, always use the Turn Off command (unless you want to use Standby or Hibernation mode as described in “Powering down the computer” on page 97).



CAUTION: The operating system records information, such as your desktop setup, during its turn-off procedure. If you don't let it turn off normally, details such as new icon positions may be lost.

Using the keyboard

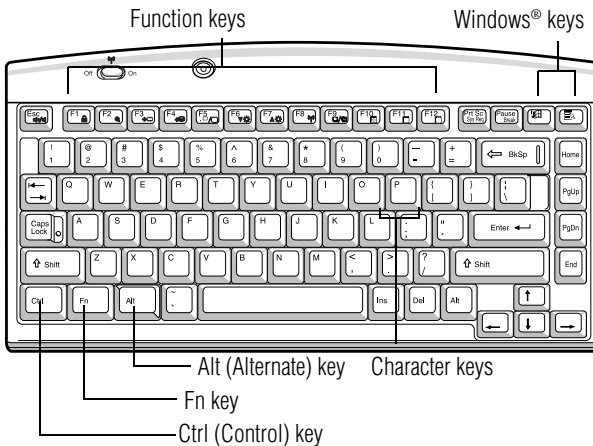

Parts of the keyboard

Character keys

Typing with the character keys is very much like typing on a typewriter, except that:

- ❖ The spacebar creates a space character instead of just passing over an area of the page.
- ❖ The lowercase letter l (el) and the number 1 are not interchangeable.
- ❖ The uppercase letter O and the number 0 are not interchangeable.
- ❖ The Caps Lock key changes only the alphabet keys to upper case — the number and symbol keys are not affected.



Ctrl, Fn, and Alt keys



Ctrl, Fn and Alt keys

The Ctrl, Fn, and Alt keys do different things depending on the program you are using. For more information, see your program documentation.

Function keys

The function keys (not to be confused with the Fn key) are the 12 keys at the top of the keyboard.



Function keys

F1 through F12 are called function keys because they run programmed functions when you press them. Used in combination with the Fn key, function keys marked with icons run specific functions on the computer.

Windows[®] special keys

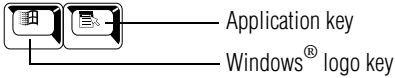

Windows[®] special keys

The keyboard provides two keys that have special functions in the operating system:

- ❖ The Windows[®] logo key opens the Start menu.
- ❖ The Application key has the same function as the secondary (or right mouse) control button.

Overlay keys

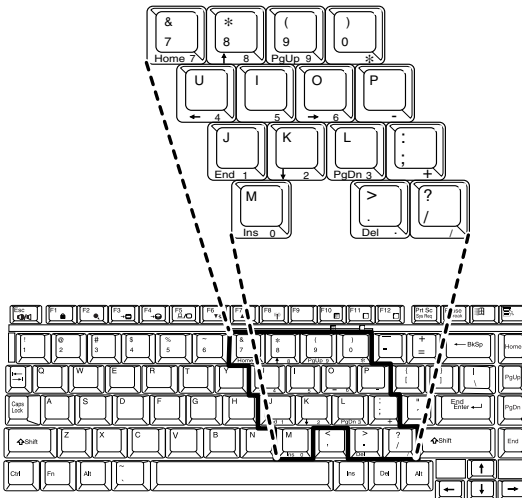

Sample keyboard overlay keys

The keys with numbers and symbols on the front of them form the numeric and cursor overlay. This overlay lets you enter numeric data or control the cursor as you would using the ten-key keypad on a desktop computer's keyboard.

Using the numeric keypad overlay



To turn on the numeric keypad overlay, press Fn and F11 simultaneously. The numeric mode light on the keyboard indicator panel glows when the numeric overlay is on.

You can still use the overlay keys to type alphabetic characters while the numeric overlay is on. To do so:

- ❖ For lowercase letters, hold down Fn while you type the letters.
- ❖ For uppercase letters, hold down both Fn and Shift while you type the letters.

To use the cursor control overlay when the numeric overlay is on, press and hold down Shift while you use the cursor control keys. To return to the numeric overlay, release Shift.

To turn off the numeric keypad overlay, hold down the Fn key and press F11 again. The numeric mode light on the keyboard indicator panel goes out.

Using the cursor control overlay



To turn on the cursor control overlay, press Fn and F10 simultaneously. The cursor control mode light on the keyboard indicator panel glows when the cursor control overlay is on.

To type alphabetic characters while the overlay is on:

- ❖ For lowercase letters, hold down Fn while you type the letters.
- ❖ For uppercase letters, hold down both Fn and Shift while you type the letters.

To use the numeric keypad overlay when the cursor control overlay is on, hold down Shift while you use the numeric overlay keys. To return to the cursor control overlay, release Shift.

To turn off the cursor control overlay, hold down the Fn key and press F10 again. The cursor control mode light on the keyboard indicator panel goes out.

Emulating a full-size keyboard

Although the computer's keyboard layout is compatible with a standard full-size keyboard, it has fewer keys.

Using the wireless keyboard

Your computer has a removable, wireless keyboard. As with the wireless mouse, this feature gives you freedom of movement when you work with your computer.

Removing the keyboard and turning it on

To remove and turn on the keyboard:

- 1 Locate the release levers on the left and right sides of your computer.
- 2 Simultaneously pull the levers out.

The top of the keyboard will pop up slightly.

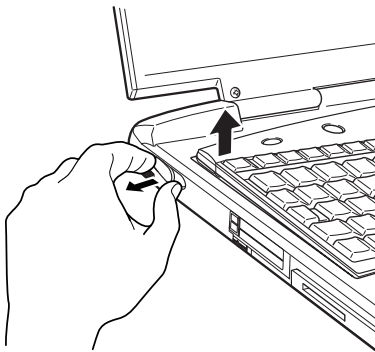

Pulling the keyboard release levers (left side shown)

3 Switch the keyboard on.

Wireless keyboard
on/off switch

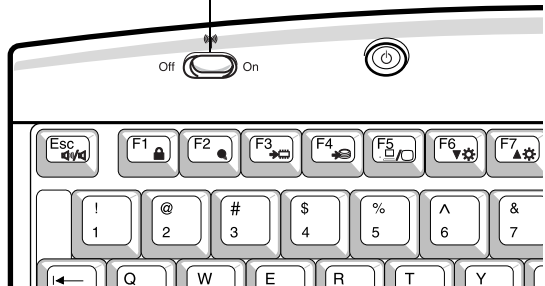

Turning on the wireless keyboard

4 Lift the keyboard up and away from the computer chassis.

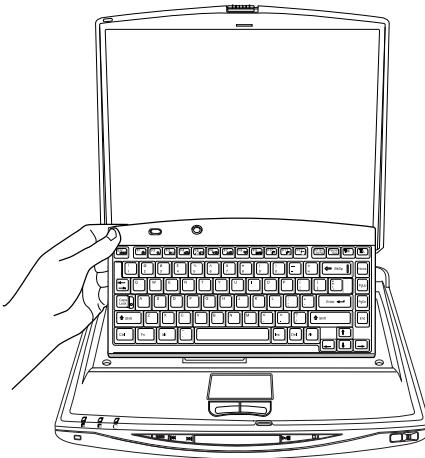

Lifting the keyboard out of the computer

You can now use the keyboard up to several feet from the computer.

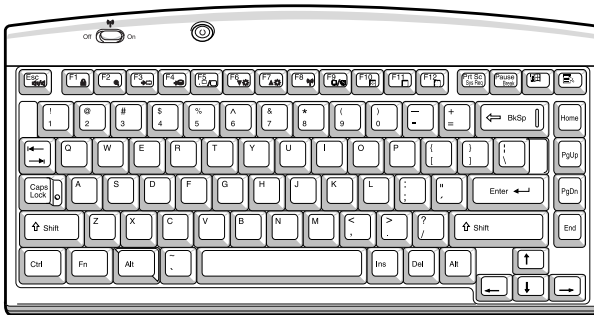

Wireless keyboard removed from the computer chassis

Installing the keyboard to the computer

To install the keyboard to the computer:

- 1 Insert the front of the keyboard into the front of the keyboard slot.
- 2 Press the top of the keyboard down to snap it into place.

Turning off the keyboard

The keyboard is automatically turned off when the computer is turned off.

Charging the keyboard

The keyboard recharges when you return it to its slot in the computer.

Changing the battery on keyboard

To change the battery on the wireless keyboard, first remove the keyboard from the computer following the procedures described in [“Removing the keyboard and turning it on”](#) on page 76.

The battery cover is found on the bottom of the keyboard when it is removed.

- 1 Remove the screw on the battery cover, and lift the cover off.
- 2 Remove the connector from the battery and lift the battery from its slot.
- 3 Replace the battery and reattach the connector removed in step 2.
- 4 Replace the battery cover and retighten the screw.

Starting a program

The easiest way to start a program is to click the name of the file that contains the information you want to work on. To find the file, use My Computer or Windows® Explorer.

If you prefer to open the program first, you have four options:

- ❖ Double-click the icon for the program on your desktop
- ❖ Use the Start menu
- ❖ Use Windows® Explorer or My Computer to locate the program file
- ❖ Use the Run dialog box

The Windows® XP operating system's tutorial chapter gives step-by-step instructions for starting a program from the Start menu. See [“Lesson 6: Starting programs” on page 132](#).

Saving your work

Before you turn off the computer, save your work to the hard disk drive or a diskette. This is one of the most important rules of computing.



NOTE: Save your data even when you are using the Standby command, in case the battery discharges before you return to work. Your computer can be configured to warn you when the battery is running low, see [“Setting battery alarms” on page 113](#).

Many programs offer a feature that saves documents at regular intervals, such as every 15 minutes. Check your programs' documentation to see whether they have an automatic save feature.

To save:

- ❖ A file you are updating, open the program's **File** menu and click **Save**.
- ❖ A new file, choose **Save As** from the **File** menu, type a name for the file, and click **OK**.



*HINT: To make another copy of the file you are currently working with, choose **Save As** from the **File** menu and give the new file a different name.*

For information on how to name a file, see [“Windows® XP file system” on page 124](#).

Printing your work

Verify that the operating system is set up for your printer as described in “Turning off the computer” on page 67.



TECHNICAL NOTE: You only need to set up the printer the first time you connect it. If you use more than one printer or are changing printers, you will need to set up the operating system to run with the additional printer(s).

To print a file:

- 1 If your printer is not on, turn it on.
- 2 In the **File** menu of your Windows® program, click **Print**.

The program displays a Print dialog box.

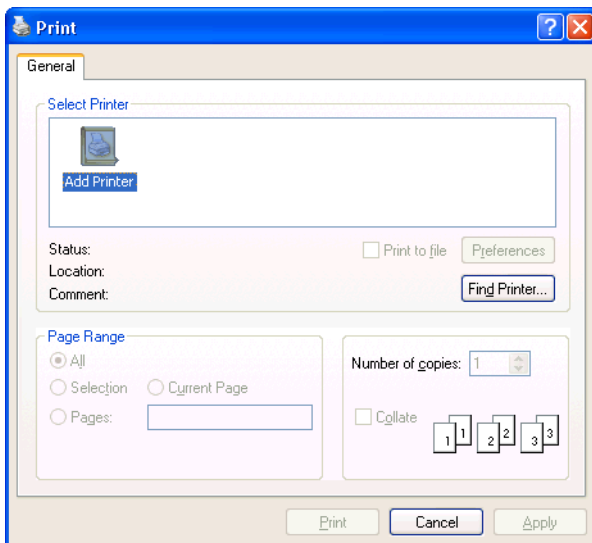

Sample Print dialog box

- 3 Click **Print** to print.

Using diskettes

The 3.5-inch internal diskette drive lets you use high-density (1.44 MB) diskettes for data transfer and storage.

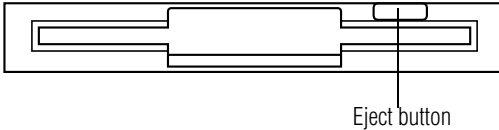

Sample external diskette drive

Inserting and removing diskettes

- 1 Hold the diskette so that the arrow on its upper surface points toward the drive.
- 2 Push the diskette gently into the drive slot. When the diskette is in place, the eject button pops out.

To release a diskette from the internal drive slot, push the eject button.



CAUTION: Never press the eject button or turn off the computer while the light is glowing. Doing so could destroy data and damage the diskette or the drive.

To access your diskette contents:

- 1 Click **Start**, then click **My Computer**.
- 2 Double-click the **3 1/2 Floppy (A:)** drive.

The diskette contents appear.

Caring for diskettes

- ❖ Store your diskettes properly to protect them and keep them clean.

-
- ❖ If a diskette is dirty, clean it with a soft cloth moistened in water. Do *not* use cleaning fluids.
 - ❖ Never slide back the protective metal cover.
 - ❖ Never touch the magnetic surface of a diskette. Fingerprints can prevent the drive from reading the data stored on a diskette.
 - ❖ Never twist or bend a diskette.
 - ❖ Keep diskettes at room temperature and avoid exposing them to direct sunlight. Otherwise data may be lost.
 - ❖ Never place heavy objects on your diskettes.
 - ❖ Never eat, smoke, or use erasers near your diskettes. Foreign particles can damage the diskette's surface.
 - ❖ Keep your diskettes away from sources of magnetism, such as speakers and radios, since these can destroy data.

Backing up your files

Backing up your files means copying individual files to a diskette or copying entire sections of your hard disk to another device, such as a tape drive.

Copying to a diskette

- 1 Insert a diskette into the internal diskette drive.
- 2 Click **Start**.
The Start menu appears.
- 3 Click **My Computer**.
The My Computer window appears.
- 4 Double-click the drive that contains the file you want to copy.

-
- 5 Double-click the folder that contains the file, then click the file you want to copy.
-



HINT: You can use the Ctrl or Shift keys to select more than one file.

- 6 Click **File**, then click **Send To**.
 - 7 Click the icon for the diskette drive (3 1/2 floppy [A:]).
-



HINT: You can also back up a file to a diskette by clicking the file (or files) you want to backup with the secondary button, then pointing to Send To and clicking 3 1/2 Floppy (A:).

Playing a CD or DVD

Your computer has a DVD-ROM or DVD-ROM/CD-RW drive that can read both DVD-ROM and CD-ROM discs.

Digital versatile discs (DVDs) provide a significant increase in data storage and support features that are not available on any other video platform. These features include wide-screen movies, multiple language tracks, digital surround sound, multiple camera angles, and interactive menus. The computer can play high-resolution video at up to 30 frames per second.



NOTE: For optimum DVD performance, it is recommended that you play DVDs while running on AC power rather than battery power.

You use CD-ROMs to load and run software, and to access reference material such as catalogs, as well as listen to music.

A special feature allows you to play audio CDs even when the computer is turned off. For more information, see [“CD/DVD control buttons”](#) on page 87.

Drive components and control buttons

The DVD-ROM or DVD-ROM/CD-RW drive is on the right side of the computer. The CD/DVD control buttons are located at the front edge of the computer and can be accessed when the display panel is closed or open.

Components

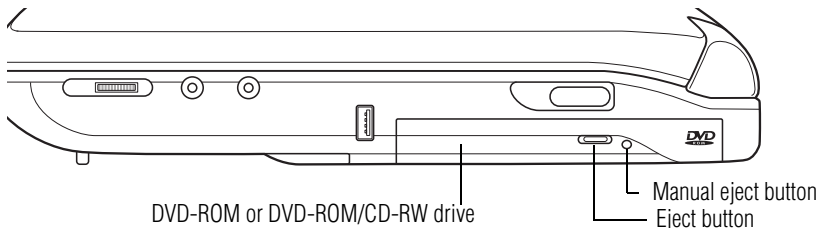

DVD-ROM or DVD-ROM/CD-RW drive

Use the eject button to release the disc tray. This button requires power to operate.



CAUTION: Never press the eject button or turn off the computer while the activity light is glowing. Doing so could damage the disc or the drive.

The manual eject button allows you to manually open the disc tray when power to the computer and the drive is off.



CAUTION: Never use a pencil to press the manual eject button. Pencil lead can break off inside the computer and damage it. Instead, use a slim object such as a straightened paper clip.



HINT: When the computer is off and the DVD-ROM or DVD-ROM/CD-RW drive is on, press the stop/eject control button to eject a disc. The computer needs to be in CD/DVD mode for this command to work properly.

CD/DVD control buttons

The control buttons on the front edge of the computer enable you to play audio CDs when the computer is off. You can also use them to play CDs and DVDs when the computer is on.

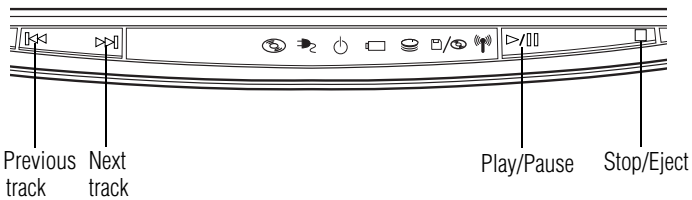

CD/DVD control buttons in front of the computer

The **mode** button switches between the CD/DVD and digital audio modes. You can lock the mode to its current setting by pressing and holding the mode button for four seconds. When the mode button is locked, you cannot switch between the CD/DVD and digital audio modes. To unlock the mode button, press and hold it for four seconds.

⏮ The **previous track** button returns to the preceding track on the disc.

⏭ The **next track** button skips to the following track on the disc.

❖ **Mode** - The left side of the indicator panel displays one of the following icons depending on what mode your computer is in:

📀 CD/DVD control

🎵 Digital audio

▶/⏸ The **play/pause** button starts playing the disc or makes it pause if currently playing.

□ The **stop/eject** button stops a disc that is currently playing.

You can eject a disc by pressing the stop/eject button twice. Use this method to eject a disc when the computer is turned off and the sound subsystem is turned on.

CD/DVD control and digital audio control

The following chart describes CD/DVD control and digital audio mode.

	<i>CD /DVD Mode</i>	<i>Digital Audio Mode</i>
Power is off and you press Play/Pause	<p>If a CD is in the drive, the system enters CD player mode and operates as a stand-alone CD player.</p> <p>If a DVD is in the drive, the operating system starts and the DVD player starts.</p>	<p>The operating system starts, the Media Player starts and the digital audio file begins to play.</p>
While in CD/DVD mode, you press the mode button	<p>DVD-ROM drive power turns off</p>	
Operating system is running and you press Play/Pause	<p>If a CD is in the drive, the Media Player starts and the digital audio file begins to play.</p> <p>If a DVD is in the drive, WinDVD starts and the DVD begins to play.</p>	<p>Media Player starts and the digital audio file begins to play.</p>

Inserting a disc



WARNING: Before playing an audio CD or a DVD, turn the volume down. Playing the disc at maximum volume could damage your ears. To turn the volume down, use the volume control dial or access the Volume Control program (click **Start, All Programs, Accessories, Entertainment, Volume Control**).

- 1 If the computer is turned on, press the eject button on the DVD-ROM or DVD-ROM/CD-RW drive.

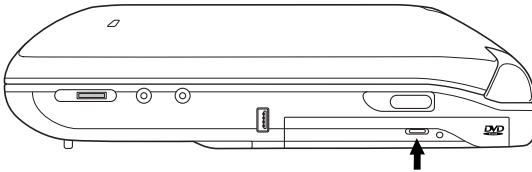

Pressing the eject button

The disc tray partially opens.



CAUTION: To avoid damaging a disc or losing data, check that the disk activity light is off before opening the disc tray.

- 2 Grasp the disc tray and pull it fully open.
 - 3 Hold the disc by its edges and check that it is clean and free of dust.
-



CAUTION: Handle discs carefully. Avoid touching the surface of the disc. Grasp it by its center hole and edge. If you handle the disc incorrectly, you could lose data.

- 4 Carefully place the disc in the empty tray with its label facing up.

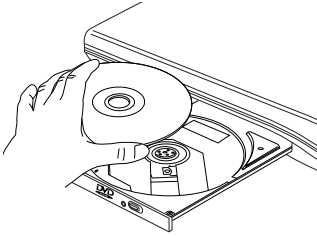

Inserting a disc



CAUTION: Be careful not to touch the drive's lens (located underneath the drive's spindle) or the area around it. Doing so could cause the drive to malfunction.

- 5 Gently press the center of the disc onto the spindle until it locks into place.

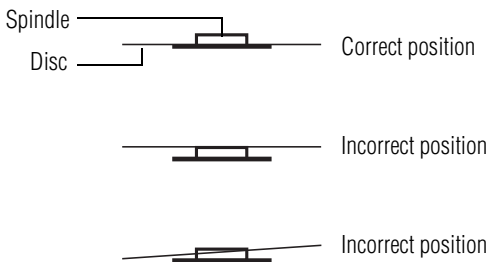

Positioning the disc on the spindle



CAUTION: Make sure the disc is properly positioned on the spindle. If you position the disc incorrectly, it can jam the disc tray.

- 6 Close the disc tray by pressing gently on the center of the tray until it clicks, indicating that it is locked.

Removing compact discs

To remove a compact disc (CD or DVD) with the computer turned on:

- 1 Press the eject button on the drive.



CAUTION: Do not press the eject button while the in-use indicator light is glowing. Doing so could damage the disc or the drive.

Also, if the disc is still spinning when you open the disc tray, wait for it to stop spinning before you remove it.

-
- 2 Pull the tray until it is fully open, remove the disc, and place it in its protective cover.
 - 3 Gently push the tray in to close it.

To remove a compact disc with the computer turned off:

- 1 Insert a slender object, such as a straightened paper clip, into the manual eject hole.
- 2 Gently pull the tray out until it is fully open, remove the disc, and place it in its protective cover.
- 3 Gently push the tray in to close it.

Playing an audio CD

Insert an audio CD and close the disc tray.

To access the Windows Media™ Player, you can open it through the Start menu or double-click the icon on the desktop.

The first time you start the Windows Media Player, it will display in Toshiba Skin mode.



Sample Windows Media™ Player Toshiba Skin

You may switch the Media Player window to full mode one of two ways:



- ❖ Click on the center of the desktop icon for the player, and select **Switch to full mode** from the pop-up menu.
- ❖ Right-click anywhere on the player, and select **Switch to full mode** from the pop-up menu.



Sample Windows Media™ Player screen

The Windows Media™ Player control panel works much like an ordinary compact disc player:

- ❖ To play the CD or to pause, click the **Play/Pause** button on the CD Player control panel.
- ❖ To stop the CD, click the **Stop** button.

Playing a DVD

This manual has an entire chapter devoted to using WinDVD™. For information about how to play back a DVD, see [“WinDVD” on page 179](#).

When you watch DVD movies on your computer using WinDVD, Toshiba highly recommends that your system’s power management utility is set to full power mode.

Viewing the contents of a CD or DVD

CDs and DVDs contain files just like diskettes and the hard disk. CDs are often used to install software or store files that require a lot of space, such as photographs and large presentation files. You can use Explorer or My Computer to view the contents of any CD or DVD.

Caring for CDs and DVDs

- ❖ Store your discs in their original containers to protect them from scratches and keep them clean.
- ❖ Never bend a disc or place heavy objects on top of it.
- ❖ Hold a disc by its outside edge. Fingerprints on the surface of a compact disc can prevent the drive from reading the data properly.
- ❖ Avoid exposing discs to direct sunlight or extreme heat or cold.
- ❖ To clean a disc, wipe it from the center outwards (not in a circle) with a clean, dry cloth. If necessary, moisten the cloth with water or a neutral cleaner (not benzine or rubbing alcohol). Let the disc dry completely before inserting it in the drive.

Using the DVD-ROM or DVD-ROM/CD-RW multifunction drive

Your computer may come with a DVD-ROM or DVD-ROM/CD-RW multifunction drive that allows you to:

- ❖ Play prerecorded DVDs
- ❖ Play prerecorded CDs
- ❖ Read and write files (including music) to a CD-Recordable (CD-R) or CD-ReWritable (CD-RW) disc.



CAUTION: Check the disc/disk activity light when you use the DVD-ROM or DVD-ROM/CD-RW drive. Do not press the eject button, disconnect a drive or turn off the computer while the light is glowing. Doing so could damage the CD, DVD or drive.

Setting up for communications

To communicate across the telephone lines with another computer, you need:

- ❖ The computer's modem
- ❖ A telephone line
- ❖ A communications program

To connect to the Internet, you need a Web browser, such as Microsoft® Internet Explorer.



TECHNICAL NOTE: Disable Call Waiting before you connect through the modem. Call Waiting interrupts data transmission.

Connecting the modem

Your computer comes with a built-in V.90 56K modem and a built-in 10/100 Ethernet LAN adapter. To use the modem, you must connect it to a standard voice-grade RJ11 telephone line.



NOTE: Due to FCC limitations, speeds of 53 kbps are the maximum permissible rates during downloads. Actual data transmission speeds will vary depending on line conditions.

- 1 Attach one end of a standard RJ11 telephone cable to the modem port on the back of the computer.

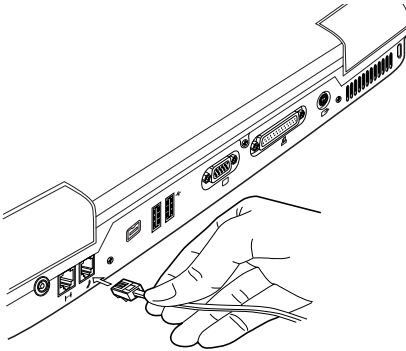

Connecting the internal modem

- 2 Plug the other end of the RJ11 telephone cable into the modular jack of a standard voice-grade telephone line.

Connecting your computer to a network

You can connect your computer to a network locally or remotely.

- ❖ Locally, using the built-in 10/100 Ethernet LAN adapter by connecting it to a standard RJ45 LAN line.

- ❖ Remotely, using the built-in modem and a dial-up connection.

To set up the network connection, use the Network Setup Wizard:

- 1 Click **Start** and point to **All Programs**.
- 2 Point to **Accessories**, then to **Communications**, and click **Network Setup Wizard**.
- 3 Follow the on-screen instructions.

The computer connects with the network.

Using the i.LINK® port

The i.LINK® port on the back of the computer provides an extremely fast data transfer rate (up to 400 mega bits per second [Mbps]). You can connect up to 63 external devices to the i.LINK® port.

In addition to high speed, the i.LINK® port also supports isochronous data—the delivery of data at a guaranteed rate. This makes it ideal for devices that transfer high levels of data in real-time, such as video devices.

As with USB ports, the i.LINK® port supports both Plug-and-Play (automatic configuration) and hot swapping (the ability to connect and disconnect devices while the computer is on.). The main difference between i.LINK® and USB technology is that i.LINK® supports faster data transfer rates.

Powering down the computer

When you power down the computer, you have three options to choose from: Turn Off (or Shut down), Hibernate and Standby. Each option has its advantages.



TECHNICAL NOTE: Before using any of these options to power down your computer, save your files and make sure the drive-in-use lights are off.

If you decide to continue working, wait a few seconds before turning the computer on again.

Turn Off or Shut down command

The Turn Off or Shut down command shuts the computer down completely.

- ❖ Use the Turn Off command if you are using the Windows® XP Home version operating system, or the Windows® XP Professional operating system when not connected to a domain server.
- ❖ Use the Shut down command if you are using the Windows® XP Professional operating system and connected to a domain server.

When you start up again, the computer runs a self-test and loads the operating system. You must open any programs and files you want to use.

Factors when choosing Turn Off or Shut down:

- ❖ No power is used while the computer is shut down. This is the most efficient mode if you will be away from your computer for an extended time.
- ❖ Restarting from Turn Off or Shut down uses the most time and battery power.

- ❖ When starting up again, the system does not automatically open programs and files you were previously using.

Hibernation command

Hibernation mode shuts the computer down completely, but it first saves the current state of the computer to the hard disk. Since Hibernation mode does not require power to maintain the saved information, the system settings are retained indefinitely. Restoring information from the hard drive takes longer than restoring it from memory. When you start up again, the computer runs a self-test, loads the operating system, and then returns to the state in which you left it.

Factors to consider when choosing Hibernation mode:

- ❖ While in Hibernation mode, the computer uses no battery power.
- ❖ Because the state of the system is held on the hard disk, no data is lost if the battery discharges.
- ❖ Restarting from Hibernation mode uses less time and battery power than restarting from Turn Off.
- ❖ Restarting from Hibernation mode uses a little more time and battery power than restarting from Standby because information is being retrieved from the hard disk instead of memory.
- ❖ When starting up again, the computer returns to the state in which you left it, including all open programs and files you were using.

Standby command

The Standby command puts the computer into a power-saving mode. Standby holds the current state of the computer in memory so that, when you restart the computer, you can continue working from where you left off.

Factors to consider when choosing Standby:

- ❖ While in Standby mode, the computer uses some battery power. A fully charged battery will last up to eight hours in Standby mode.
-



NOTE: If you power down using the Standby command and the battery discharges fully, your information will be lost. Be sure to save your work often.

- ❖ Restarting from Standby mode uses less time and battery power than restarting from Turn Off or Hibernation mode.
 - ❖ When starting up again, the computer returns to the state in which you left it, including all open programs and files you were using.
-



TECHNICAL NOTES: Before using any of these options to power down your computer, save your files and make sure the drive-in-use lights are off.

If you change your mind and decide to continue working, wait a few seconds before turning the computer on again.

Using Turn Off or Shut down

For the Windows® XP Home operating system, follow these steps to shut down the computer:

- 1 Click **Start**, select **Turn off computer**.

The Turn off computer dialog box appears.

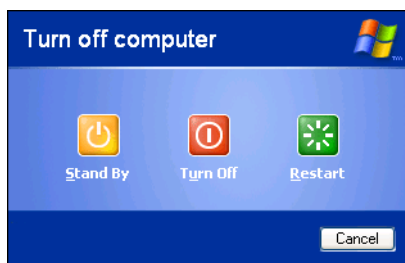

Sample Turn off computer dialog box

- 2 Click **Turn Off**.

The computer shuts down completely.

For the Windows® XP Professional operating system, follow these steps to shut down the computer:

- 1 Click the **Start** button, then **Shut down**.

The Shut Down Windows dialog box appears.

- 2 Select **Shut down** from the drop-down list.
- 3 Click **OK**.

The computer shuts down completely.

Shutting down more quickly

You can also shut down the computer by pressing the power button or closing the display panel.

To use either of these methods, you first need to turn on the feature in Toshiba's Power Saver utility.

- 1 Click **Start**, then click **Control Panel**.

The Control Panel appears.

- 2 Click the **Performance and Maintenance** icon.



- 3 Click the **Toshiba Power Management** icon.

- 4 Select the **Advanced** tab.

The following screen appears.

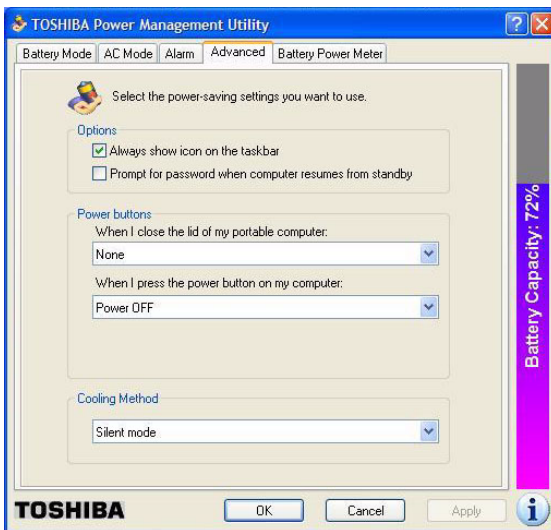

Sample System power mode settings

- 5 Select **Power Off** for the options you want.

- ❖ **When I press the power button**
Set this option to Shutdown to have the computer shut down when you press the power button.
- ❖ **When I close the lid**
Set this option to Shutdown to have the computer shut down when you close the display panel.

- 6 Click **OK**.

-
- 7 Close the Control Panel.
-



NOTE: For more information about the Power Saver utility, see “Power Management” on page 176.

Starting again after Turn Off or Shut Down

To start the computer up again, press and hold the power button until the on/off light changes to green.

Using Hibernation

Hibernation mode shuts the computer down completely, but it first saves the current mode of the computer to the hard disk. Since Hibernation mode does not require power to maintain the saved information, the system settings are retained indefinitely. Restoring information from the hard disk takes longer than restoring it from memory. When you start up again, the computer runs a self-test, loads the operating system, and then returns to the mode in which you left it.

Factors to consider when choosing Hibernation:

- ❖ While in Hibernation mode, the computer uses no battery power
- ❖ Because the mode of the system is held on the hard disk, no data is lost if the main battery discharges
- ❖ When starting up again, Hibernation uses less time and battery power than does Turn Off Computer
- ❖ Restarting from Hibernation uses a little more time and battery power to start up than restarting from Standby, because information is being retrieved from the hard disk rather than from memory
- ❖ When starting up again, the computer returns to the mode in which you left it, including all open programs and files you were using

Configuring your computer for Hibernation:



- 1 Open the **Start** menu, then click **Control Panel**.
- 2 Click the **Performance and Maintenance** icon, and then click the **Toshiba Power Management** icon.
- 3 Click the **Advanced** tab.
- 4 Select **Hibernation** for the options you want.

When I press the power button

Set this option to Hibernation so that the computer will go into Hibernation mode when you press the power button.

When I close the lid

Set this option to Hibernation so that the computer will go into Hibernation mode when you close the display panel.

- 5 Click **OK**.
- 6 Close the Control Panel.

The computer is now set to automatically go into Hibernation when your option settings occur.



NOTE: For more information about the Power Saver utility, see "Power Management" on page 176.

Once the computer is configured, put the computer into Hibernation mode by either pressing the power button or closing the display panel, depending on the hibernation options taken.

Starting again from Hibernation mode

To start up the computer from Hibernation mode, press the power button until the on/off light turns green. The computer returns to the screen you were using.

Using Standby

The Standby command puts the computer into a power-saving mode. Standby holds the current mode of the computer in memory so that, when you restart the computer, you can continue working from where you left off.

Factors to consider when choosing Standby:

- ❖ While in Standby mode, the computer uses some battery power. A fully charged main battery will last up to eight hours in Standby mode.
- ❖ Restarting from Standby uses less time and battery power than restarting from Turn Off Computer or Hibernation.
- ❖ When starting up again, the computer returns to the mode in which you left it, including all open programs and files you were using.



NOTE: If you power down using the Standby command and the main battery discharges fully, your information will be lost. Be sure to save your work first.

To power down the computer using the Standby command, click **Start**, **Turn Off Computer**, and select **Stand By**.

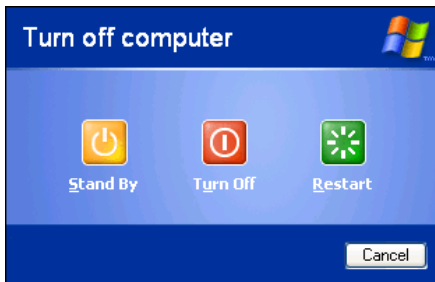

Sample Turn off computer dialog box



NOTE: If you hold down the shift key, Stand By becomes Hibernate in the Turn Off Computer dialog box. To enter hibernation mode, you must hold down the shift key while you select Hibernate.

The computer saves the status of all open programs and files to memory, turns off the display, and goes into a low-power mode. The on/off light blinks amber indicating the machine is in Standby mode.

Going into Standby mode more quickly

In addition, you can put the computer into Standby mode by either pressing the power button or closing the display panel. You can also specify an amount of time after which the computer automatically goes into Standby mode.

To use any of these methods, you first need to enable them in Toshiba's Power Saver utility.

- 1 Open the **Start** menu, then click **Control Panel**.
- 2 Click the **Performance and Maintenance** icon, and then click the **Toshiba Power Management** icon.
- 3 Click the **Advanced** tab.
- 4 Select **Standby** for the options you want.

When I press the power button

Set this option to Standby to put the computer into Standby mode when you press the power button.

When I close the lid

Set this option to Standby to put the computer into Standby mode when you close the display panel.

- 5 Click **OK**.

6 Close the Control Panel.



NOTE: For more information about the Power Saver utility, see "Power Management" on page 176.

Starting again from Standby mode

To start up the computer from Standby mode, press the power button until the on/off light changes to green. The computer returns to the screen you were using.



NOTE: If you power down using the Standby command and the battery discharges fully, your information will be lost. Be sure to save your work often.

Toshiba's online resources

Toshiba maintains a number of online sites to which you can connect. These sites provide information about Toshiba products, give help with technical questions, and keep you up to date with future upgrades. For more information, see ["Contacting Toshiba" on page 235](#).

Chapter 4

Mobile Computing

This chapter covers all aspects of using your computer while traveling.

Toshiba's energy-saver design

Your computer enters a low-power standby mode when it is not being used, thereby conserving energy and saving money in the process. It has a number of other features that enhance its energy efficiency.

Many of these energy-saving features have been set by Toshiba. We recommend you leave these features active, allowing your computer to operate at its maximum energy efficiency, so that you can use it for longer periods while traveling.

Running the computer on battery power

The computer contains a removable Lithium Ion (Li-Ion) high-capacity battery that provides power when you are away from an AC outlet. You can recharge it many times.

Battery Notice

To ensure that the battery maintains its maximum capacity, operate the computer on battery power at least once a month until the battery is fully discharged. Please see “[Maximizing battery life](#)” on page 118 for procedures. If the computer is continuously operated on AC power, either through an AC adapter or a docking station (if applicable to your system), for an extended period (more than a month) the battery may fail to retain a charge. This may shorten the life of the battery, and the battery light may not indicate a low-battery condition.

In addition, the computer has an internal real-time clock (RTC) battery. This is a nickel metal hydride (NiMH) battery. The RTC battery powers the RTC memory, which stores your system configuration settings and the current time and date for up to a month while the computer is turned off.

Using additional batteries

If you spend a lot of time traveling and need to work for many hours without an AC power source, you may want to carry additional charged batteries with you. You can then replace a discharged battery and continue working.



NOTE: For optimum DVD performance, Toshiba recommends that you play DVDs while running on AC power rather than on battery power.

Charging batteries

The main battery needs to be charged before you can use it to power the computer. You can charge the battery using your computer, or you can use an optional battery charger.



CAUTION: Never leave batteries in the battery charger for more than a week at a time. Doing so may reduce the potential charge of the battery.

Use only battery chargers designed to work with your notebook computer. You can order a Toshiba battery charger from Toshiba's Web site at toshiba.com.

Charging the main battery

To charge the main battery while it is in your computer, plug the computer into a live wall outlet. It takes several hours to charge the battery with the computer off. It takes much longer to charge the battery while the computer is on.



TECHNICAL NOTE: The battery may take longer to charge with many applications open at the same time.

The battery may not start charging immediately if:

- ❖ The battery is extremely hot or cold.

To ensure that the battery charges to its full capacity, wait until it reaches room temperature (50 to 80 degrees Fahrenheit, 10 to 26 degrees Celsius).

- ❖ The battery is almost completely discharged.

Leave the power connected, and the battery should begin charging after a few minutes.

Charging the RTC battery

The computer contains an internal battery that provides power for the real-time clock (RTC) and calendar.

During normal use, the main battery keeps the RTC battery adequately charged. Occasionally, the RTC battery may lose its charge completely, especially if you have had the computer turned off for a long time.

If the RTC battery is low, the real-time clock and calendar may display the incorrect time and date, or stop working.

To recharge the RTC battery, plug in the computer and leave it turned on for 10 or more hours.



NOTE: It is seldom necessary to charge the RTC battery because it charges while the computer is off. If the RTC battery is low, the real-time clock and calendar may display the incorrect time and date or stop working.

When Hibernation mode is enabled and the RTC battery is completely discharged, a warning prompts you to reset the real-time clock.

The computer can be used while the RTC battery is being charged, although the charging status of the RTC battery cannot be monitored.

Monitoring battery power

 The battery light indicates the main battery's current charge. It:

- ❖ Glows amber while the battery is being charged.
- ❖ Glows green when the battery is fully charged.
- ❖ Is not lit when the computer is not connected to an external power source.

Determining remaining battery power



NOTE: Wait at least 16 seconds after turning on the computer before trying to monitor the remaining battery power. The computer needs this time to check the battery's remaining capacity and perform its calculations.

-
- 1 Click **Start**, then click **Control Panel**.

The Control Panel appears.

- 2 Click the **Performance and Maintenance** icon.



- 3 Click the **Toshiba Power Management** icon.

- 4 Click the **Battery Power Meter** tab. The current power source and battery power remaining section displays the current charge state of the battery. The value displays as a percentage of remaining battery charge.



TECHNICAL NOTE: The computer drains the battery faster at low temperatures. Check your remaining charge frequently if you are working in temperatures below 50 degrees Fahrenheit.

The computer calculates the remaining battery charge based on your current rate of power use and other factors such as the age of the battery.

Conserving battery power

How long a fully charged battery lasts when you are using the computer depends on a number of factors, such as:

- ❖ How the computer is configured
- ❖ How much you use the display panel instead of an external monitor
- ❖ How much you use the hard disk and other drives
- ❖ Whether you use any optional devices to which the battery supplies power, such as a PC Card
- ❖ Where you are working—since operating time decreases at low temperatures

Toshiba's power-saving options greatly increase the length of time you can use the computer before it becomes necessary to recharge the battery.

Toshiba has combined these options into preset power usage modes.

You may also set individual power-saving options to suit your own needs. See [“Power Management” on page 176](#) for details.

What to do when the battery runs low

When the battery runs low you can:

- ❖ Plug the computer into an external power source and recharge the battery.
- ❖ Put the computer in Hibernation mode and replace the battery with a charged spare.
- ❖ Save your work and turn off the computer.

If you don't manage to do any of these things before the battery completely runs out of power, the computer automatically enters Hibernation mode and turns itself off. Hibernation mode keeps track of where you were so, when

you turn on the power again, you can continue where you left off.

The computer stores the information on what you were doing until the battery runs out of power. If you have Hibernation mode enabled (the default), the computer copies the details of your open programs and files to the hard disk before shutting down.

Setting battery alarms

Your computer can be configured to warn you when the battery is running low.

You can set multiple alarms. Each alarm can be set to alert you when a specified percentage of remaining battery power has been reached. You can set how the warning occurs: sound an alarm, display a message, both, or none. You can also set the computer to enter Stand By mode or Hibernation mode, or to Turn Off when the alarm goes off.

To set an alarm:

- 1 Click **Start**, then click **Control Panel**.

The Control Panel appears.

- 2 Click the **Performance and Maintenance** icon.

- 3 Click the **Toshiba Power Management** icon.



- 4 Click the **Alarm** tab and set the alarm, as desired.

Changing the main battery

When your battery power is running low, you have two options: connect the computer to an AC power source or install a charged battery.



NOTE: If your battery discharges fully, your information will be lost. Be sure to save your work often.



CAUTION: When handling a battery, be careful not to drop it or short-circuit its terminals.

Removing the battery from the computer

- 1 Save your work.
- 2 Turn off the computer or place it in Hibernation mode according to the instructions in [“Using Hibernation” on page 102](#).
- 3 Remove all cables connected to the computer.
- 4 Close the display panel and turn the computer upside down with the front of the computer facing you.

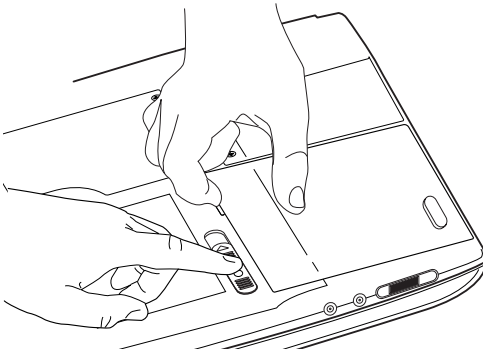

Sliding the battery release latch

- 5 Carefully slide the battery release latch toward the center of the computer.

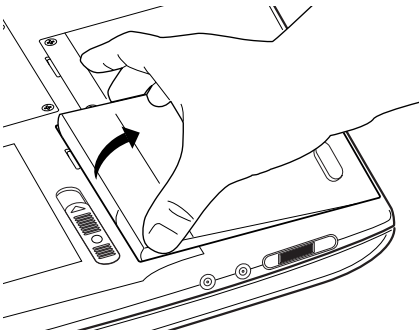

Sliding the battery out

- 6 While holding the battery release latch toward the unlocked position, use the adjacent half-oval finger slot nearby to gently pull the battery pack free.



WARNING: If the battery is leaking or its case is cracked, put on protective gloves to handle it, and discard it immediately following the advice in *"Disposing of used batteries safely"* on page 119.

Inserting a charged battery

- 1 Wipe the battery terminals of the charged battery with a clean cloth to ensure a good connection.
- 2 With the battery release latch pulled toward the unlocked position, insert the battery from the back end first at a slight angle so that end fits evenly with the surrounding casing. If the back end has been correctly inserted, you will be able to gently press the front end into place until it snaps shut. If the front end resists, don't force it. Simply start over.

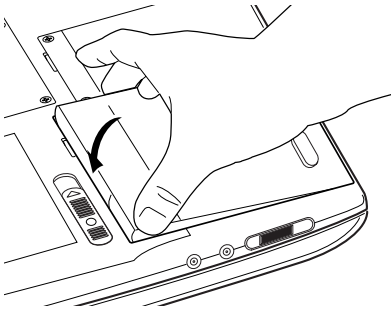

Inserting the battery



CAUTION: Failure to lock the battery cover can result in the battery falling out of the computer case.

- 3 Turn the computer right side up.
- 4 Reconnect any cables you removed.
- 5 Turn on the computer.

Safety precautions

- ❖ If the battery pack produces an odor, overheats or changes color or shape while it is being used or charged, turn off the computer's power immediately and disconnect the power cord from the power socket. Carefully remove the battery pack from the computer.
- ❖ Do not try to disassemble a battery pack.
- ❖ Do not overcharge or reverse charge a battery. Overcharging will shorten its life, and reverse charging could damage it.
- ❖ Avoid touching the metal terminals of the battery with another metal object. Short-circuiting the battery can cause it to overheat and may cause damage to the battery or the computer.
- ❖ Do not incinerate a spent battery, as this could cause it to explode and release toxic materials.
- ❖ If a battery is leaking or damaged, replace it immediately. Use protective gloves when handling a damaged battery.
- ❖ To replace the main battery, use an identical battery that you can purchase through toshiba.com
- ❖ Reverse Polarity should be avoided with all batteries. The main battery is designed so that it cannot be installed in reverse polarity.
- ❖ Charge the battery pack only in the computer or in a battery charger designated as an approved option.
- ❖ When you install the battery pack, you should hear a click when it is seated properly.
- ❖ Do not expose the battery pack to fire. The battery pack could explode.

Maximizing battery life

To maximize the life of your battery pack:

- ❖ At least once a month, disconnect the computer from a power source and operate it on battery power until the battery pack fully discharges. Before doing so, follow the steps below:
 - 1 Turn off the computer's power.
 - 2 Disconnect the AC adaptor and turn on the computer's power. If it does not turn on, go to step 4.
 - 3 Operate the computer on battery power for five minutes. If the battery pack has at least five minutes of operating time, continue operating until the battery pack is fully discharged. If the battery light LED flashes or there is some other warning to indicate a low battery, go to step 4.
 - 4 Connect the AC adaptor to the computer and the power cord to a power outlet. The DC IN or AC power-light LED should glow green, and the Battery LED should glow amber to indicate that the battery pack is being charged. If the DC IN or AC power-light indicator does not glow, power is not being supplied. Check the connections for the AC adaptor and power cord.
 - 5 Charge the battery pack until the Battery LED glows green.
- ❖ If you have extra battery packs, rotate their use.
- ❖ If you will not be using the system for an extended period, more than one month, remove the battery pack.
- ❖ Disconnect the AC adaptor when the battery is fully charged. Overcharging makes the battery hot and shortens life.
- ❖ If you are not going to use the computer for more than eight hours, disconnect the AC adaptor.

- ❖ Store spare battery packs in a cool dry place out of direct sunlight.

Disposing of used batteries safely

You can recharge a battery many times. When the battery needs replacing, the battery light flashes amber shortly after you have fully recharged the battery.

You must discard a battery if it becomes damaged.



CAUTION: The computer's main battery is a Lithium Ion (Li-ion) battery, which can explode if not properly replaced, used, handled, or disposed of. Putting spent batteries in the trash is not only irresponsible, it may be illegal. Dispose of the battery as required by local ordinances or regulations.

Use only batteries recommended by Toshiba.

The materials that came with your computer may include an insert regarding the disposal of batteries. If not, check with your local government agency for information on where to recycle or dispose of old batteries.

Traveling tips

The environmental precautions listed in “[Selecting a place to work](#)” on page 39, also apply while travelling.

- ❖ Never leave your computer on a sunny ledge or in a place where it could get wet or covered in dust.
- ❖ Always travel with the computer in a carrying case. Toshiba offers a choice of carrying cases for the computer. They all provide plenty of extra space for manuals, power cables, compact discs and diskettes. Contact your authorized Toshiba representative for more information, or visit toshibaaccessories.com.



TECHNICAL NOTE: When traveling by air, you may be required to pass your notebook through airport security equipment. The X-ray equipment will not harm your computer.

Chapter 5

Getting to Know the Windows[®] XP Operating System

This chapter introduces the Windows[®] XP operating system by guiding you through a few basic tasks.

Whether you have used a Windows[®] operating system or not, the skill and confidence you will gain from this chapter will more than offset the short amount of time spent going through these lessons.

As you explore the Windows[®] XP operating system further, you will often discover alternative ways of accomplishing a particular task.

For more detailed information on your operating system, refer to the Microsoft[®] Windows[®] XP operating system documentation that came with your computer.



HINT: The illustrated examples in this guide may appear slightly different from the screens displayed by your system. However, the differences are not significant and do not indicate any change in the functionality of your system.

Lesson 1: Exploring the desktop

The desktop is the launching pad for everything you can do in the operating system. You use its features to start programs, find documents, set up system components, and perform most other computing tasks.

Finding your way around the desktop

Your computer's desktop includes several standard features: icons, Start button, taskbar, system tray, and background pattern.

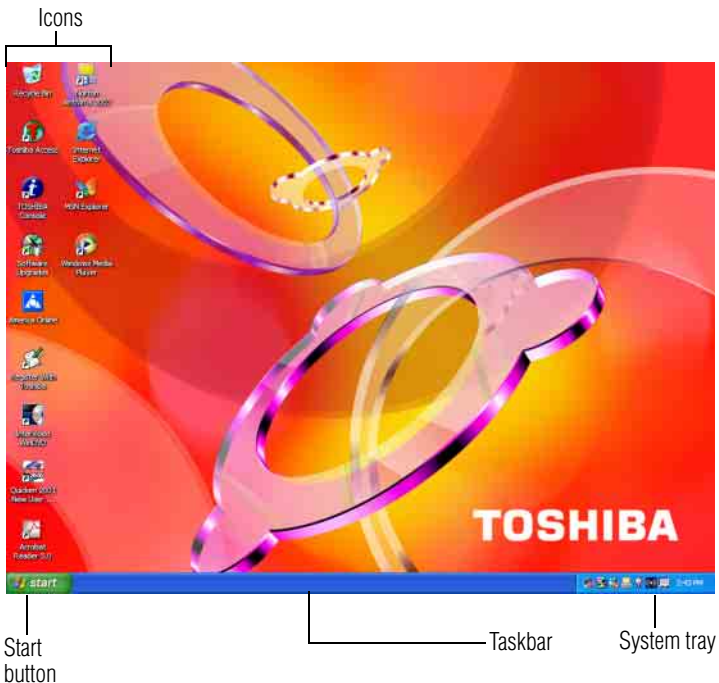

Sample Desktop

Icons

An icon represents a folder, file, or program that can be quickly activated by double-clicking the icon.

You can create a new desktop icon for any folder, file, or program by dragging the element's icon from its location in a window to the desktop area.

The icons initially displayed on your system desktop include:



Recycle Bin — Holds files you've deleted. You may be able to retrieve these files until you empty the Recycle Bin.



TECHNICAL NOTE: If you delete a file from a diskette, it does not go into the Recycle Bin. For more information on the Recycle Bin, see Windows® online Help.



Internet Explorer — The Microsoft® browser that provides access to the Internet.



NOTE: If you place the cursor over an icon, a popup description of the file contents appears.

Your desktop may contain other icons depending on your configuration. See Windows® XP online Help for more specific information on each icon and how to use it.

Start button

You use the Start button to:

- ❖ Start programs
- ❖ Access operating system update information
- ❖ Open recently accessed documents
- ❖ Adjust system settings

- ❖ Search for files
- ❖ Access Windows® Help and Support
- ❖ Run programs
- ❖ Suspend system activity and turn off the computer

For more information on starting programs, see “[Lesson 6: Starting programs](#)” on page 132.

Taskbar

Each time you open a program, a button associated with that program appears on the taskbar. With some programs, a button appears on the taskbar for each document or window you open. You can use these buttons to quickly switch between the programs or windows.

To make a program or window the active one, click the program’s or window’s button.

System tray

The System tray displays icons of tasks or programs that run continuously in the background. To learn more about each task, position the cursor over the icon for a few moments and a short description of the task appears.

Typical tasks in the System tray are Current time, Power usage mode, and speaker volume.

To activate a specific task, double-click the appropriate System tray icon.

Windows® XP file system

All files on your computer are organized for accessibility using a hierarchal file system.

Programs, documents, and other data are held in *files*. These files can be grouped together in *folders*, and folders can be grouped inside other folders for convenient organizing. All

the files and folders reside in your computer on a storage *device*, such as a disk drive.

You can think of your computer storage system in terms of office equipment. You have a file cabinet (device), that contains folders, and each folder may contain documents. Your office may have more than one file cabinet, just as your computer may have more than one disk drive.

Computers can be connected together to form a *network*, so that programs, documents and other data can be quickly and easily shared between computers.

You can use the My Computer feature accessible through the Start menu to access any file in the Windows® file system.

For more information, read the Microsoft® documentation that comes with your computer.

Lesson 2: Using the TouchPad and control buttons together

The “Getting Started” chapter introduced you to TouchPad, which is your basic tool for moving around the screen. This lesson lets you practice using the TouchPad and control buttons in tandem.

- 1 Using the TouchPad, move the pointer to the **Start** button on the screen, then click the primary button (usually the left) of the adjoining control buttons to open the Start menu.



NOTE: In this guide, the term “click” refers to the primary button, which is usually the left one. Instructions requiring the secondary button specifically mention that button. For example, “click the secondary button.”

- 2 Click an empty area of the desktop to close the **Start** menu.

- 3 With the pointer in an empty area of the desktop, click the secondary button to open the desktop shortcut menu.

As the name implies, shortcut menus provide quick access to many operating system features.

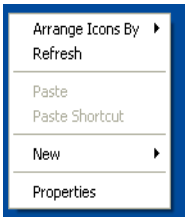

Sample desktop shortcut menu

- 4 Click an empty area to close the shortcut menu.
- 5 Click **Start**, then click **My Computer**.

The operating system opens the My Computer window.

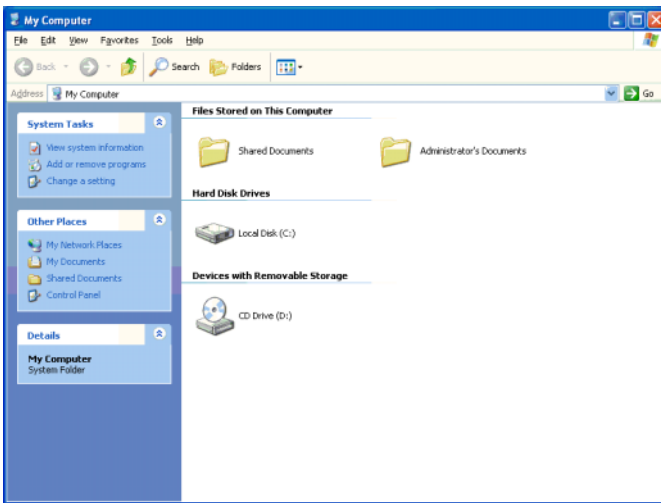

Sample My Computer window open



- 6 Now click the **Close** button in the upper-right corner of this window.

The My Computer window is closed.

- 7 Click an empty area of the taskbar at the bottom of the screen and, while holding down the primary button, use the pointing device to drag the pointer to the right edge of the desktop, then release the primary button. (This process is known as “clicking and dragging.”)

The taskbar moves from the bottom to the right edge of the desktop.



Sample desktop with the taskbar on the right



HINT: You can move the taskbar to any of the desktop's four edges.

- 8 Click the taskbar once again and drag it back to the bottom of the desktop.

If you can't move the taskbar, it's probably because it has been locked.

To unlock it:

- 1 Right-click the taskbar.
A menu appears. If the Lock the taskbar option has a check mark, then the feature is in use.
- 2 Click **Lock the taskbar**.
- 3 Call up the menu again. The check mark should be gone, indicating the lock has been removed.

Follow the same steps to lock the taskbar.

You can also lock and unlock the taskbar by using the Taskbar and Start Menu Properties window.

To access the window:

- 1 Right-click the taskbar, then select **Properties**.
The Taskbar and Start Menu Properties window appears.
- 2 Check or uncheck the box next to the Lock the taskbar command.
- 3 Click **OK**.

Lesson 3: Learning about the Internet

This lesson demonstrates how to access a Web page from a window and from the taskbar.

The lesson assumes you have an account with an Internet Service Provider (ISP).

Opening a Web page from a window

The most common way to open a Web page is by typing a Web address in the address line of the Web browser itself. But you can also type a Web address in the My Computer window.

- 1 Click **Start**, then **My Computer**.
The My Computer window appears.

- 2 On the **View** menu, point to **Toolbars**, then click **Address Bar**.

The operating system displays the address bar. It indicates that you are in “My Computer.”

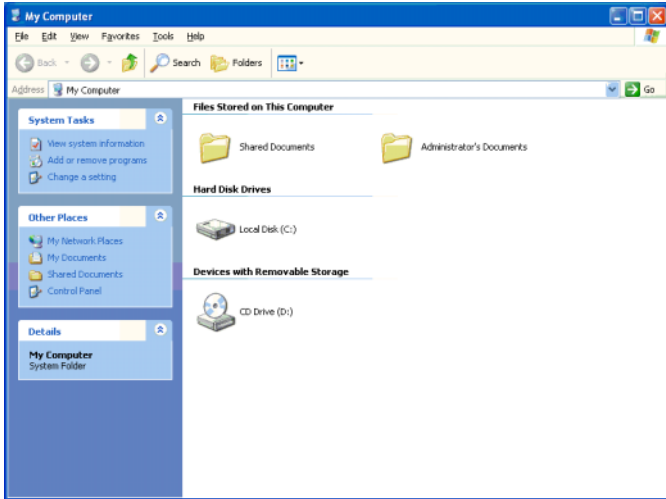

Sample My Computer window

Lesson 4: Creating a new document

This lesson teaches you how to create a text file without having to first open a program.

- 1 Move the pointer to an empty area of the desktop, then click the secondary button.

The operating system displays a shortcut menu of commands applicable to the desktop.

- 2 Click **New**, then click **Text Document**.

The operating system creates an icon on the desktop called New Text Document with the icon name highlighted.

- 3 To give your document a meaningful name, type My New Doc.txt and press Enter.
- 4 Double-click the **My New Doc** icon.

The operating system opens the new document in Notepad—the text editor built into the operating system.



Sample Notepad window

Notice that when the document opens, there is a new button on the taskbar that reads New Doc.txt- Notepad (the name may be too long to fit into the taskbar space but, if you point to the name, the complete name is visible). By displaying buttons like this one, the taskbar helps you keep track of the programs and files you currently have open.

To learn more about Notepad, open the Help menu by pressing F1. For now, leave Notepad open and go on to the next lesson.

Lesson 5: Creating a new folder



DEFINITION: A folder is an area where you can store documents and other types of files. It is analogous to a file folder stored in a file cabinet. In this case, a disk drive in the computer is the file cabinet.

The operating system stores documents and programs in folders. It even stores other folders in folders. In this lesson, you will create a folder in which to store your new document.

- 1 Move the pointer to an empty area of the desktop, then click the secondary button.

The operating system displays the desktop shortcut menu.

- 2 Click **New**, then click **Folder**.

The operating system creates an icon on the desktop called New Folder with the icon name highlighted.

- 3 Type a name for the folder, such as **My Folder**, then press Enter.



- 4 Close the Notepad document you just created by clicking the **Close** button on the right side of the Notepad title bar.

The operating system displays the document as an icon on the desktop.

- 5 Click the document icon and drag it toward your New Folder icon. Position the document icon over the New Folder icon until it changes color, then release the primary button.

The outline of the document icon moves across the desktop and disappears into the folder.

- 6 To see your document, double-click the folder icon.

A window opens and displays the contents of the folder.



- 7 Close the window by clicking its **Close** button and continue with the next lesson to learn how to start programs.

Lesson 6: Starting programs

Usually, you will know which program you want to use for a particular task.

This lesson teaches you how to launch programs from the Start menu, using two of the programs that are built into the operating system: Paint and Windows® Explorer.

To use Paint to launch programs:

- 1 Click **Start**, then point to **All Programs**.
- 2 Click **Accessories**.
- 3 Click **Paint**.

The operating system opens Paint—a basic drawing program.

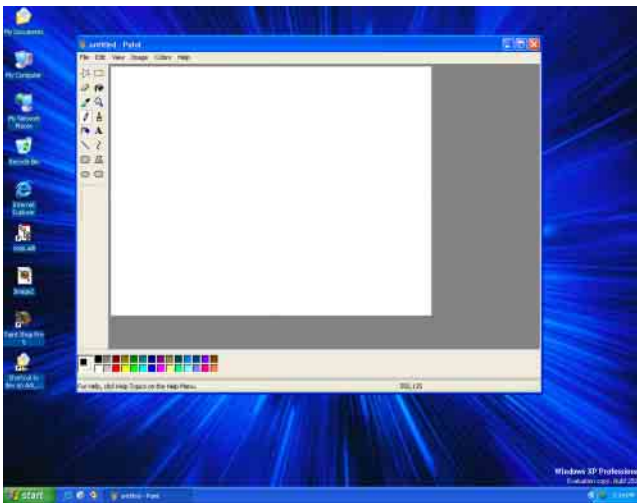

Sample Paint window

To use Windows Explorer to launch programs:

- 1 Click **Start**, then point to **All Programs**.
- 2 Click **Accessories**.
- 3 Click **Windows Explorer**.

The operating system opens Windows® Explorer, which provides access to all your computer's resources. For example, it lets you see all the files in a particular folder on the computer's hard disk.

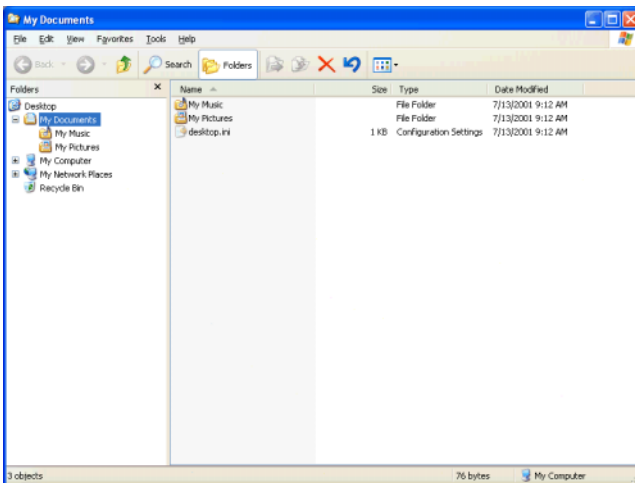

Sample Windows Explorer window

Notice the taskbar now has two buttons on it—one for Paint and one for Windows® Explorer.

- 4 Click the **Paint** button on the taskbar.

The operating system displays the Paint program.

The operating system places the active window on top of other windows on the desktop unless you have selected a different display option. You can move back and forth between the two programs by clicking each button alternately.

Lesson 7: Resizing, repositioning, and hiding windows

If you have followed the lessons in this chapter, you now have a screen with several program windows open. You can organize these windows by resizing and repositioning windows so that you can see more than one of them at a time. You can also hide windows by removing them from the desktop without actually closing your document or program.

This lesson introduces several ways to adjust the size, shape, and position of windows open on the desktop.

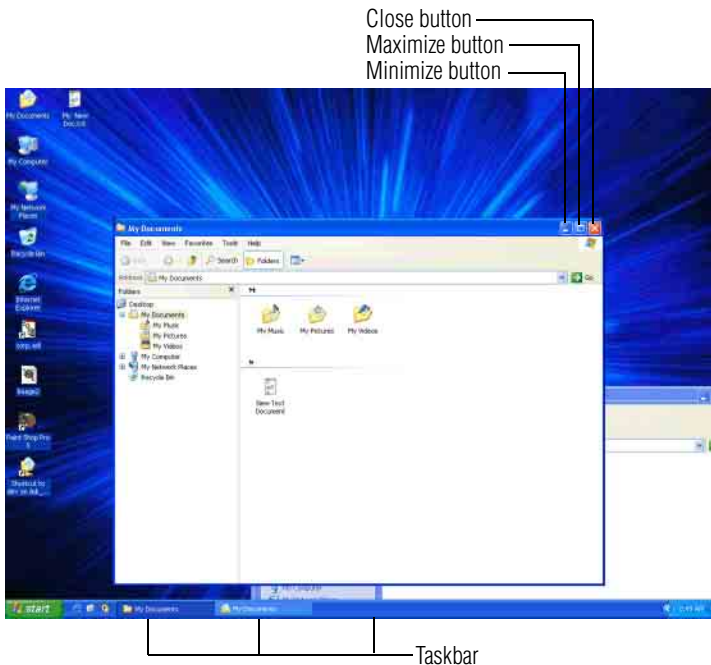

Sample Windows® Explorer open on the desktop

Using the taskbar

If you have application windows open on the desktop, you can rearrange them by clicking and dragging the program's button on the taskbar. You have these options:

- ❖ Move windows
- ❖ Size windows
- ❖ Minimize all windows — display only the taskbar buttons
- ❖ Maximize windows
- ❖ Close windows

Choose your option depending on how you wish to set up your desktop.

Minimizing and maximizing windows

- 1 To make the Explorer window the active window, click the **Windows Explorer** button on the taskbar.

The operating system highlights the Windows® Explorer title bar to show that Windows® Explorer is the active window.



- 2 Click the **Minimize** button at the top-right of the Explorer window to hide the window.

Windows® Explorer disappears from the desktop. However, it is still open, as you can see from the taskbar.



HINT: Minimizing program windows is a good way to clean up the desktop without actually closing programs.



- 3 Click the **Maximize** button in the top-right corner of the Paint window.

The Paint window expands to fill the screen, hiding everything except the taskbar. Notice that the Maximize button has changed. It is now called the Restore button.



HINT: Maximizing a program is a good way to work when you are only using that program and do not want any distractions on the screen.

Resizing and moving windows



- 1 Click the **Restore** button in the top-right corner of the Paint window.

Paint returns to its previous size and location. Notice that the Restore button has changed back into the Maximize button.

For the next few steps assume that you want to be able to see both Paint and Windows® Explorer at the same time.

- 2 Move the pointer to the right-hand edge of the Paint window.

The pointer changes to a two-headed arrow.

- 3 Click and drag the edge of the window until it takes up just less than half the width of the desktop.
- 4 Click the title bar of the Paint window and drag it to the left side of the desktop.

You can move any window by clicking its title bar and dragging it.

- 5 Click **My Documents** on the taskbar.
- 6 Repeat steps 3 and 4 to change the size and position of Windows® Explorer, placing it on the right side of the desktop.

Now that the windows are side by side, you can see how you could refer to one window while working in the other.

Resizing and moving windows allows you to rearrange the desktop to suit your needs. Experiment with different sizes and placements of windows to find the best arrangement for your work.

At this point you have two programs open on the desktop. The next lesson shows you how to close them.

Lesson 8: Closing programs

Once you are finished working with a document or program, it is a good idea to close it. While you can run several programs at the same time, having a large number of programs and documents open simultaneously can slow down your computer.

This lesson teaches you how to close the programs you opened earlier in this tutorial.

To close the programs:



- 1 Click the **Close** button at the top-right of the Explorer window.

That is all there is to it. Windows® Explorer closes, removing the Explorer button from the taskbar as well.

- 2 Close Paint and the My Computer window (assuming it is still open) by clicking the **Close** buttons for each program.



HINT: Always save your work before you close a program.

Lesson 9: Creating shortcuts

By adding shortcuts to your desktop, you can open programs or files with the click of a button. You will probably want to create shortcuts for the programs you use most frequently. This lesson explains how to create shortcuts using two operating system accessories, Calculator and Character Map, as examples.

Creating a shortcut to the Calculator

Use this method when you know the name and location of the program file to which you would like to create a shortcut.

- 1 Move the pointer to an empty area of the desktop, then click the secondary button.

The operating system displays the desktop shortcut menu.

- 2 Click **New**, then click **Shortcut**.

The operating system displays the Create Shortcut dialog box.

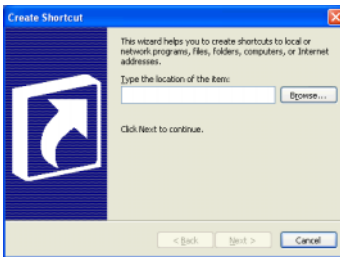

Sample Create Shortcut dialog box

- 3 In the **Command line** box, type `c:\windows\system32\calc.exe` and click **Next**.

The operating system prompts you to select a name for the shortcut.

- 4 Type Calculator and click **Finish**.

The operating system displays the new shortcut on your desktop.

Creating a shortcut to the Character Map

Use this method when you don't know the name and location of the program file.

- 1 Click **Start**, then click **Search**.

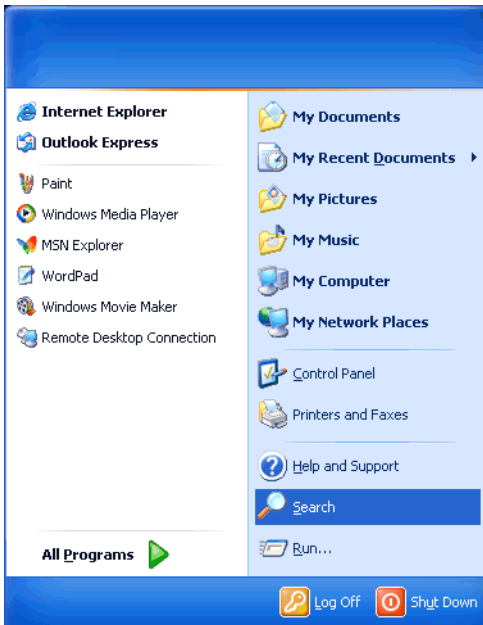

Sample Search option on the Start menu

The operating system displays the Search dialog box.

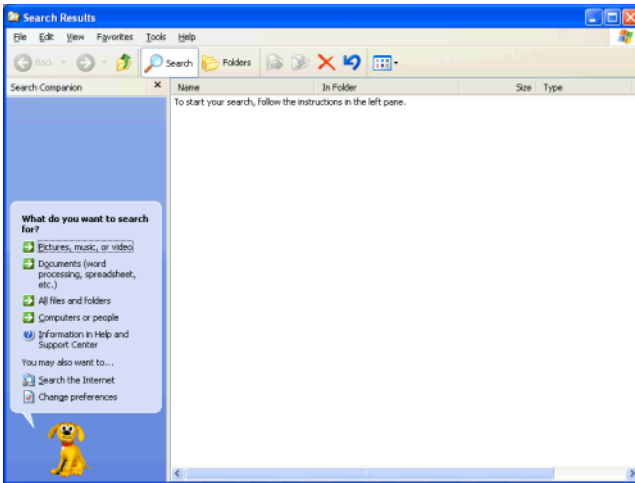

Sample Search Results dialog box



HINT: Search also allows you to perform searches on the Internet.

- 2 Click **All files and folders**.
- 3 Type char in the text box labeled: In all or part of the file name.
- 4 Click **Search**.

The operating system displays a list of all the files with “char” in their names.

- 5 Select the **Character Map** file with the secondary button, then drag and drop it on the desktop.

A shortcut to the Character Map appears on your desktop.

6 In the shortcut menu, click **Create Shortcut(s) Here**.

NOTE: Shortcut icons can be recognized by an arrow in the lower left corner. Deleting or changing the shortcut icons will not affect the program to which they refer.

Clicking a shortcut icon opens the program or folder immediately. You can place as many shortcuts on your desktop as you find useful.



HINT: The Character Map is a useful tool when you want to add a special character to a document.

Lesson 10: Changing the screen saver

You can personalize the background area of your desktop with pictures, patterns, or colors. The background is considered a “property” of your desktop. This lesson will not only teach you how to change the background, but will also introduce you to properties.

The Windows® XP operating system treats all windows, icons, programs, drives, etc. as self-contained objects, each with its own set of properties (such as size, position on-screen, and color). Many of these properties can be customized to meet your particular needs and tastes.



DEFINITION: An object is an independent block of data, text, or graphics that was created by an individual application.

This lesson introduces object properties by showing you how to change one of the properties of the desktop—the screen saver. This is a continuously changing pattern that appears on the screen during pauses in your work.

- 1 Move the pointer to an empty area of the desktop, then click the secondary button.

The operating system displays the desktop shortcut menu.

- 2 Click **Properties**.

The operating system opens the Display Properties dialog box.

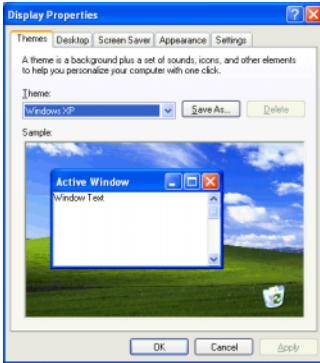

Sample Display Properties dialog box

- 3 Click the **Screen Saver** tab.
- 4 Click the arrow beside the current option—probably “(None)” —to open the screen saver list box.
- 5 Scroll through the screen saver options by clicking the scroll arrows in the list box.
- 6 Try a screen saver pattern by clicking a name in the list box.

The operating system displays your selection in the monitor above the list box. Try several patterns.
- 7 To apply a pattern to your desktop, click **Apply**.
- 8 After you have chosen a screen saver pattern and applied it to your desktop, click **OK**.

The operating system returns you to the desktop.

You can view any object's properties by clicking the object with the secondary button, then choosing **Properties** from the shortcut menu that appears.

The next lesson explains how to set two other properties—the date and time.

Lesson 11: Setting the date and time

You initially set the computer's date and time properties when you turned the computer on for the first time and set up the operating system.

To change the date and time settings:

- 1 Click **Start**, then click **Control Panel**.

The Control Panel appears.

- 2 Click the **Date, Time, Language, and Regional Options** icon.

- 3 Click the **Date and Time** icon.

The operating system displays the Date/Time Properties dialog box.

- 4 Click one of the following:

- ❖ **Change the date and time** in the **Pick a task** section
- ❖ **Date and Time** in the **or pick a Control Panel icon** section

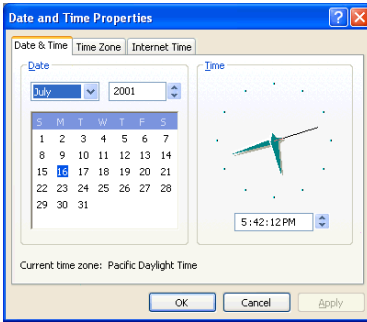

Sample Date and Time Properties dialog box



HINT: To open the Date and Time Properties dialog box more quickly, either click the time display on the taskbar with the secondary button, then click Adjust Date/Time, or double-click the time display.

- 5 Click the **Date and Time** tab and set the correct month, year, day, and time.
- 6 Click the **Time Zone** tab and drop-down list box, and set your time zone.
- 7 Click **OK**.
- 8 Close the Control Panel.

Lesson 12: Removing objects from the desktop

Earlier in this tutorial, you created a new icon on the desktop. Since everything you have done to this point has been just practice, you may want to return the desktop back to its original uncluttered state. This lesson explains how to remove objects from the desktop and introduces the Recycle Bin.

- 1 Click the **New Folder** icon you created, drag it until it is over the Recycle Bin icon and it changes color, then release the primary button.

The icon disappears, but, with the operating system, it is not really gone. It is merely set aside in the Recycle Bin so that you can restore or delete it later.

- 2 Repeat step 1 for any other icons you created during this tutorial.

Each icon disappears as you drop it on the Recycle Bin.



- 3 Double-click the **Recycle Bin** icon.

The operating system opens the Recycle Bin window. Notice that all the icons you dropped on the Recycle Bin are listed.

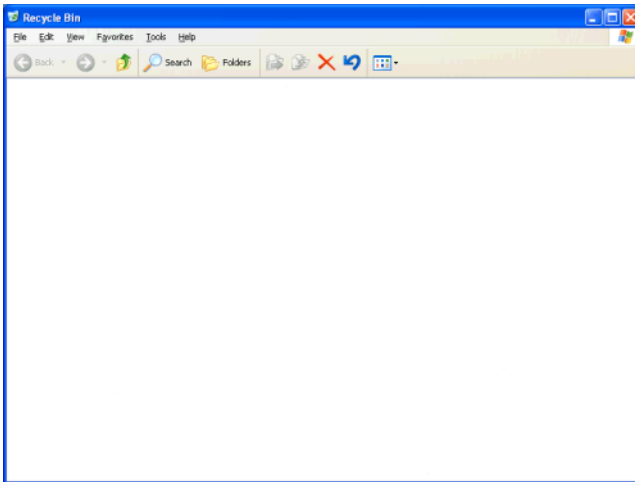

Sample Recycle Bin window

- 4 To completely remove an object, select it, and then click **File, Delete**.

The Confirm File Delete window appears.

- 5 Click **Yes** to permanently delete the file.

The object is permanently deleted from the Recycle Bin.

Later on—in your real work, not in this tutorial—you will use the Recycle Bin to delete other objects such as folders,

documents, and sometimes even programs. Still, the process is the same. Just drag an object's icon to the Recycle Bin.

If you change your mind and want to restore an object you sent to the Recycle Bin, select the object with the secondary button and click **Restore**. The operating system restores the object to the place from which it was deleted. You can also restore the object by dragging it to the desktop.

But when you are absolutely certain that you never want to see it again, delete it from the Recycle Bin.

To delete everything from the Recycle Bin at once, choose **Empty Recycle Bin** from the File menu.



HINT: Empty the Recycle Bin periodically. Even though an item is moved to the Recycle Bin, it still uses valuable space on the hard disk drive until it is deleted from the Recycle Bin.

Lesson 13: Using System Restore

The System Restore feature allows you to return your computer to the way it was configured on a specific date or time, a “restore point.” This is useful if you are reconfiguring your computer for new hardware or software. In the event that your hardware or software causes your computer to malfunction, you can remove the offending item(s) and restore the system to the state it was in at the preset time.

To get to System Restore, click **Start**, click **All Programs**, point to **Accessories** and **System Tool**, and click **System Restore**.

The System Restore Welcome screen appears.

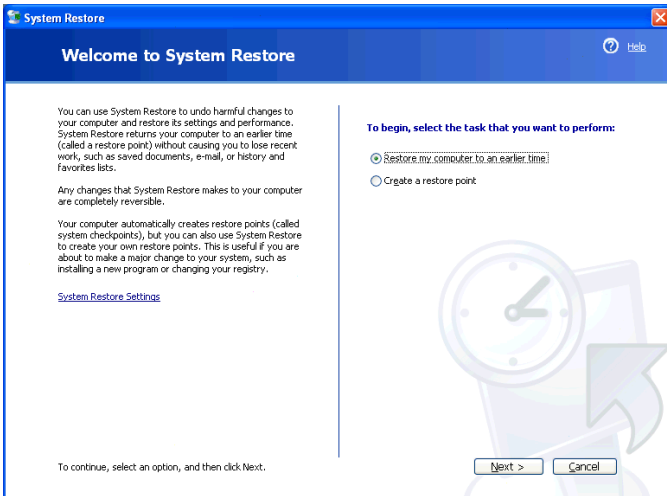

Sample System Restore welcome screen

The Windows® XP operating system guides you through the process of storing your system settings for future use. It also guides you through restoring your system to the selected date or time.

Lesson 14: If I am lost, what do I do?

This teaches you how to use some of the Help features in the Windows® XP operating system.

Windows® XP Help and Support

The operating system has a Help facility. If you cannot figure out how to do something, the answer is probably only a few clicks away.

Assume that you want to draw a picture, but don't know how.

- 1 If you don't have an application open, press F1, otherwise click **Start**, then click **Help and Support**.

The operating system opens the Help and Support Center window.

- 2 If you do not see the index, click **index**.

Help and Support displays the Index.

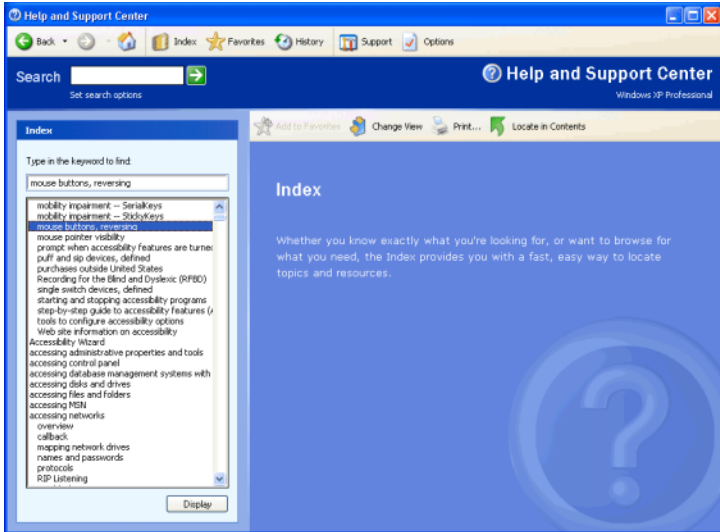

Sample Help and Support Index

The left side of the screen contains the index. The text box above the index, where the cursor is flashing, lets you type in a topic you want to find in the index.

- 3 Type drawing in the text box.

Notice as you type that the index moves to locate what you typed.

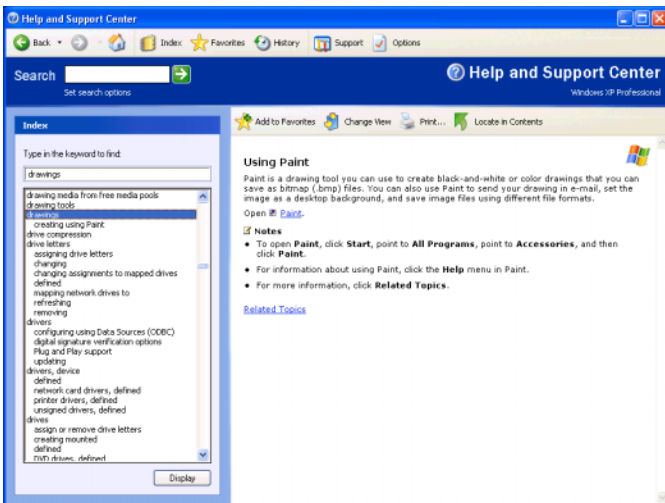

Sample help window for drawings

Notice that under the category drawings, there is a subcategory: creating using Paint.

4 Highlight creating using Paint, then click **Display**.

Help opens a topic screen that, in the window's right pane, gives a brief description of Paint and provides different ways for accessing the program, including through use of a hot link ([Paint](#)).

Not every Help topic contains a hot link to start the program it is talking about. However, when you do encounter one, it provides a convenient way to start the program to look at it while you read about the program in the Help topic.

Using the Windows® XP tour

Whether you are new to computers or you have some experience, the Windows® XP tour is a good way to start.

To start the tour:

1 Click **Start**, then click **Tour Windows XP**

The Windows® XP Tour window appears.

- 2 Follow the instructions.



Sample Windows® XP Tour window

Lesson 15: Turning off your computer

It is very important that you let the operating system turn off your computer. As it shuts down, the operating system performs a number of tasks that ensure that everything is in place the next time you turn on the computer. This lesson teaches you how to turn off your computer.

- 1 Click **Start**, then click **Turn Off Computer**.

The Turn off computer box appears.

- 2 Click **Turn Off**.

The computer turns off.

There are other ways to shut down your computer. For more information, see [“Powering down the computer”](#) on page 97.

Chapter 6

Exploring Your Options

In this chapter, you will explore other features of your notebook computer.

Windows® XP special features

The Windows® XP operating system offers you several new features and enhancements, including:

- ❖ New system file protection
- ❖ A system restore function, allowing you to rollback the system to its previous mode
- ❖ An improved help center, support automation, and automatic Windows® operating system update
- ❖ Wizards to simplify setting up your home network
- ❖ Ability to share one Internet connection among multiple PCs
- ❖ An automatic discovery feature that allows your computer to detect new and intelligent devices

Personalizing your desktop

Your desktop is your virtual workspace. This section explains how to customize its features for the way you like to work. You can customize the following aspects of the desktop:

- ❖ Taskbar — which resources to display for quick access
- ❖ Web content — what information from the Internet to always display
- ❖ Desktop style — how windows are displayed and how to browse folders and files
- ❖ Toolbars — what information appears at the top of each window

Customizing the taskbar

As you work, the taskbar changes to reflect what you are doing. Its icons provide shortcuts to programs, documents, files, folders, system features, and components. Open applications also have Forward and Backward buttons to allow navigation through folders, documents, and Web sites.

For example, you can personalize the taskbar to include your favorite URL addresses or local folders and programs.



DEFINITION: URL stands for Uniform Resource Locator, which is the address that defines the route to a file on the Web or any other Internet facility. Generically, it is known as the World Wide Web site address.

Having a list of favorite URLs handy saves time. Using it bypasses the need for you to launch your browser first.

To customize your Taskbar settings, point to an empty space in the taskbar and click the secondary button.

Changing desktop and browsing style

The operating system enables you to customize the way you view your desktop and browse the files and folders on your local computer or network file server.

You can make it so that:

- ❖ Items that normally require a double-click will open with a single click.
- ❖ Folders will open in their own window instead of in the same window.
- ❖ Folders are accompanied by a list of common tasks instead of displayed alone.

The options you choose determines how you browse in the operating system, regardless of whether you start from the desktop, My Computer, Windows Explorer, or Internet Explorer.

For more information about changing your desktop style, enter Desktop on the Index tab in Help and Support.

Choosing a style

To select desktop and browsing style options:

- 1 Click **Start**, then click **My Computer**.
The My Computer window appears.
- 2 Select the **Tools** menu, then click **Folder Options**.
The Folder Options dialog box appears.

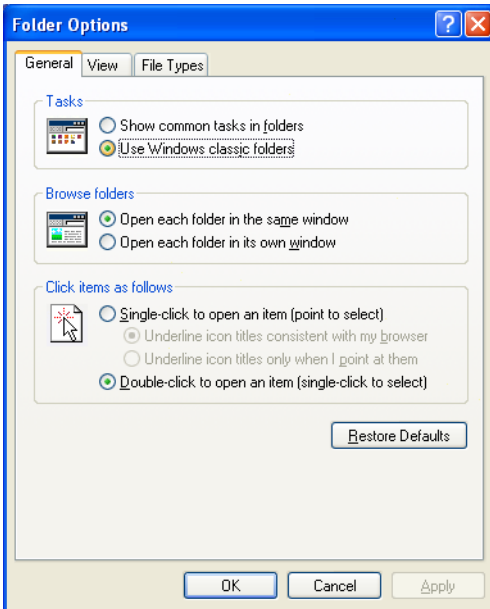

Sample Web-style option

- 3 Click the preferred options.
- 4 Click **Apply**, click **OK**.

Personalizing individual windows

Just as you can display a Web page on your desktop, you can also display a Web page in an individual window. If you subscribe to the Web page, it can be automatically updated on a regular basis. For example, using this Web integration feature you can monitor weather, game scores, stock prices, or headlines — all in the window of your choice.

Customizing window toolbars

You can display one or more customizable toolbars at the top of a window. As you browse, the operating system detects the kind of information presented in the window and automatically displays the appropriate toolbar buttons and menus.

You can also add these toolbars to the taskbar.

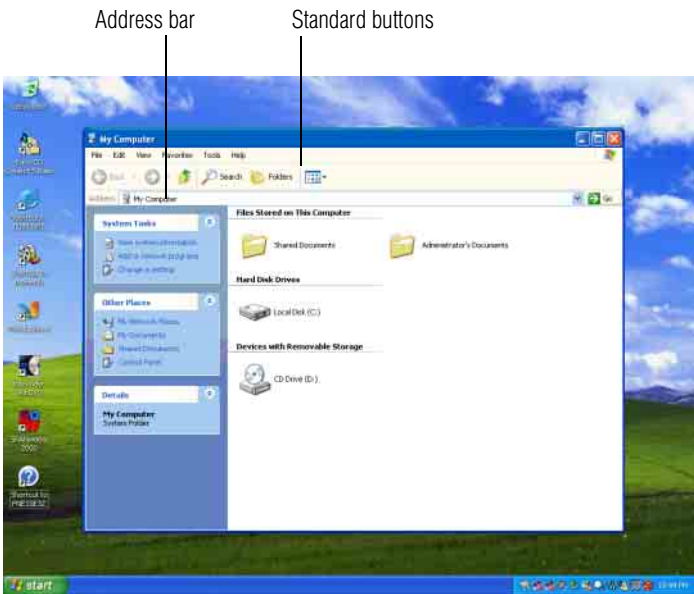

Sample toolbar locations

The elements you can add to the top of the window are:

<i>Toolbar element</i>	<i>Description</i>
Address Bar	Opens Web pages, programs, folders, or documents. By default, the address bar shows your current location, and whether it is a folder or a Web page. You can browse to another location by typing an address — a URL, a path, or even a program name. If you start typing a previously typed address, the AutoComplete feature finishes the address for you.
Standard buttons	Displays buttons for commonly used commands, such as copying, pasting, deleting items, changing views, and browsing backward and forward.

Displaying a toolbar in a window

- 1 Click **Start**, then click **My Computer**.

The My Computer window appears.

- 2 On the View menu, point to Toolbars, then click the name of the toolbar you want to display.

The toolbar appears below the menu bar of the current window.

Displaying information about each folder

In addition to displaying the contents of each window, you might find it helpful to have the operating system display the name of the folder and brief information about how to use the folder.

- 1 Click **Start**, then click **My Computer**.

The My Computer window appears.

- 2 Double-click the folder you want to open.
- 3 In the **Tools** menu, select **Folder Options**.
The Folders Options box appears.
- 4 In the Tasks section, click the button for **Show common tasks in folders**.
- 5 Click **Apply**, then **OK**.
Helpful information on how to use the folders appears on one side of the window.

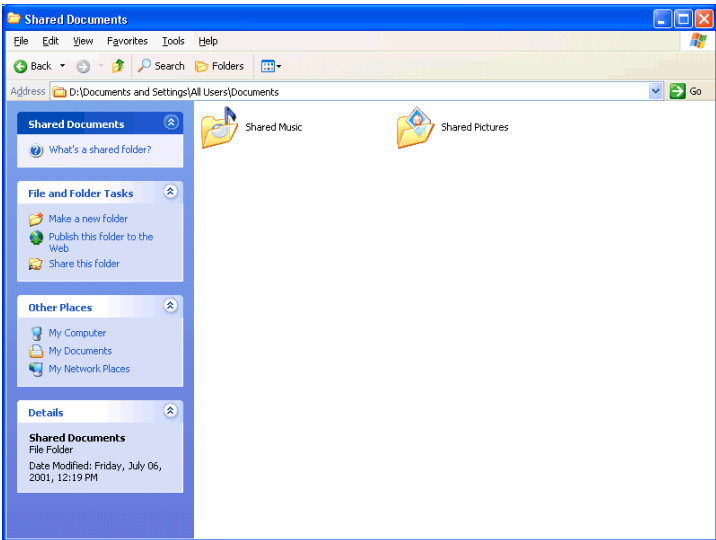

Sample folder with how-to information

To remove the informational boxes:

- 1 In the **Tools** menu, select **Folders Options**.
The Folders Options box appears.
- 2 In the Tasks section, click the button for **Use Windows classic folders**.
- 3 Click **Apply**, then **OK**.

Using your computer at the office

By connecting an external monitor, external full-size keyboard, an external mouse and an external diskette drive, you can work with your notebook as if it were a standard office computer.



An external monitor connects to the RGB (monitor) port.



An external mouse, keyboard and diskette drive connect to the USB ports.

Setting up for communications

In order to connect to the Internet, use an online service, or communicate across the telephone lines with another computer, you need:

- ❖ A modem (one comes with your computer)
- ❖ A telephone line
- ❖ A browser or communications program
- ❖ An Internet Service Provider (ISP) or online service if you plan to use the Internet

Determining the COM port

Your modem is connected to one of the computer's COM (communications) ports. The default setting for the modem is COM3.

The following procedure is intended to support you if you need to either upgrade your modem or reset the port to the default settings.

If you're having trouble connecting through the modem, you may need to determine the current COM port name and possibly change it.

To find out which port your modem is connected to in the operating system:

- 1** Click **Start**, then click **Control Panel**.

The Control Panel appears.

2 Click **Printers and Other Hardware**.

3 Click **Phone and Modem Options**.

The Phone and Modem Options window appears.

4 Click the **Modems** tab.

A location box appears.

5 In the **Attached to** field, the COM port is specified.

6 Your modem should be listed under **Modem**.

7 To verify that the modem is set up properly:

❖ Click the port to which your modem is connected.

❖ Click **Properties**.

❖ Click the **Diagnostics** tab.

❖ Click **Query Modem**.

The Modem AMR Properties box appears.

8 Click the **General** tab.

The computer should indicate whether the modem is working properly.

9 If the modem isn't working properly, click **Troubleshooting** and follow the instructions.

10 Click **OK** to close the properties box, then the Phone and Modem Options box.

11 Close the Control Panel.

Connecting the modem to a telephone line

Before you can use the modem, you must connect it to a standard voice-grade telephone line. See “[Connecting the modem](#)” on page 95.



TECHNICAL NOTE: If you are using the telephone line at home, disable Call Waiting before you connect through the modem. Call Waiting interrupts data transmission.

Connecting your computer to a network

You can connect your computer to a network to increase its capabilities and functionality.

Accessing a network

To access:

- ❖ A wired network at the office, connect an Ethernet cable to the RJ45 jack on your computer.
- ❖ A remote network, you need a dial-up connection.
- ❖ A wireless network, you need a wireless networking PC Card, or contact your authorized Toshiba representative.

Setting up the connection

To set up a dial-up connection, use the New Connection Wizard:

- 1** Click **Start** and point to **All Programs**.
- 2** Point to **Accessories**, then to **Communications**, and click **New Connection Wizard**.
- 3** Follow the on-screen instructions.

The computer connects to the network.

Setting up a wireless connection

For information on how to set up a wireless connection, refer to your wireless networking device documentation.

Accessing the wireless modules using your system tray

The following information applies to systems with the optional Wi-Fi features:

When using your Wi-Fi Mini PCI module, your computer may display a PC Card icon in the desktop's system tray to indicate that it is in use. Do not confuse the system tray's icon with other removable PC Card devices you may have installed.

You *can* use the system tray's PC Card icon to turn off your Wi-Fi Mini PCI module. However, you will need to restart your computer to turn your Wi-Fi Mini PCI module back on.

Your Wi-Fi Mini PCI module is integrated into your computer system. It is recommended that you do not remove the module from your computer. For assistance, contact a Toshiba Wireless Authorized Service Partner.

Setting up a direct cable connection

To establish a direct cable connection with another computer:

- 1 Click **Start, All Programs**.
- 2 Point to **Accessories, Communications**, and click **New Connection Wizard**.
- 3 Click **Next**.
- 4 Select **Set up an advanced connection**.
- 5 Click **Next**.
- 6 Select **Connect directly to another computer**.
- 7 Choose the appropriate role for your computer:
 - ❖ Guest

❖ Host

8 Follow the on-screen instructions.

An overview of using the Internet

The following sections give a quick introduction to the Internet and some of its exciting features, under these headings:

❖ [The Internet](#)

❖ [The World Wide Web](#)

❖ [Internet Service Providers](#)

❖ [Connecting to the Internet](#)

❖ [Surfing the Internet](#)

❖ [Internet features](#)

❖ [Uploading and downloading files from the Internet](#)

For more information about the Internet, [“Lesson 3: Learning about the Internet”](#) on page 128.

The Internet

The Internet is an association of thousands of networks and millions of computers around the world connected by communications lines. They all work together to share information.

The World Wide Web

The World Wide Web (or ‘Web’) is a subset of the Internet — a collection of interlinked documents (located on computers connected to the Internet) that work together using a specific Internet protocol called Hypertext Transfer Protocol (HTTP).

The World Wide Web offers information as text, images, audio, or video to be referenced from anywhere in the world. Special programs called Web browsers are specifically designed to work with HTTP. They make it easier to connect

to a particular network address and send and receive information.

Internet Service Providers

To connect a computer directly to the Internet, many people and businesses use an Internet Service Provider (ISP). An ISP is a company that has the equipment and the telecommunication lines necessary to maintain an Internet connection.

You can connect to the Internet by using a telephone and modem or through other higher-speed communication methods such as Digital Subscriber Lines (DSL), cable, and satellite links.

Connecting to the Internet

To connect to the Internet, you need:

- ❖ A modem
- ❖ A Web browser
- ❖ A telephone line
- ❖ An Internet Service Provider (ISP) account

Once you have established an ISP account, you can access the Internet.

- 1 Connect your computer's modem to a telephone line.

For more information on connecting a modem, see [“Connecting the modem” on page 95](#).

- 2 Start your Web browser. Have your modem dial the ISP's telephone number, and establish a connection with the ISP's computer.

Surfing the Internet

Once connected to the Internet, the Web browser displays a home page, for example, your ISP's home page on the Internet or your company's Web site home page.

To visit a desired Web site, type in the Web address. The Web address, or Uniform Resource Locator (URL), is a unique identifier for that computer system linked to the Internet. Web addresses can also appear within a Web page's text, and are known as links. Clicking a link automatically transfers your Web browser to that site.

You can also use a Search Engine, a Web site specifically designed to help you look for information.

Internet features

The Internet offers many types of communication tools to help you perform many tasks.

❖ Internet email

To send and receive email of your own, you need a mailbox on the Web, or an email address.

If you have an account with an ISP, you can probably set up an email address at the same time as you sign up for the service.

❖ Internet chat rooms

A chat room is a Web site that offers a place where people with similar interests and ideas can communicate in real-time, one-on-one or in groups, by typing messages which are instantly viewed by others on their computer screens.

❖ Internet news groups

A news group is similar to a chat room, but instead of using a dedicated site to converse about a specialized subject with others in real-time, it uses a Web site as a

clearinghouse where all the messages are placed, like a gigantic bulletin board.

❖ Online shopping

Many Web sites offer products and services for sale.

Uploading and downloading files from the Internet

Transferring files from one computer to another is termed uploading (transferring data from your computer to a site on the Web), or downloading (transferring data from a site on the Web to your computer).

There are several ways to upload or download data. It can be as simple as attaching a file or document to an email, or you can use the File Transfer Protocol (FTP) features of your Web browser to transfer large amounts of data.

Exploring video features

Your computer's video features include:

- ❖ Viewing Windows[®] presentations or DVD movies either on the computer screen (display panel or external monitor) or on a television set.

Viewing presentations or DVD movies on your television

Your computer is equipped with an S-video jack and an audio/headphones jack.



NOTE: Video cables are not included with your computer. You will need to purchase the appropriate video cable.

To view a DVD movie or Windows[®] presentation in full-screen mode on your TV:

- 1 Connect the S-video cable to your television.



NOTE: Video cables are not included with your computer. To connect a device to the S-video jack, you'll need to purchase the appropriate cable.

- 2 Change the display properties setting to 800 x 600:
 - ❖ Right-click anywhere on your desktop and select **Properties**.

The Display Properties dialog box appears.

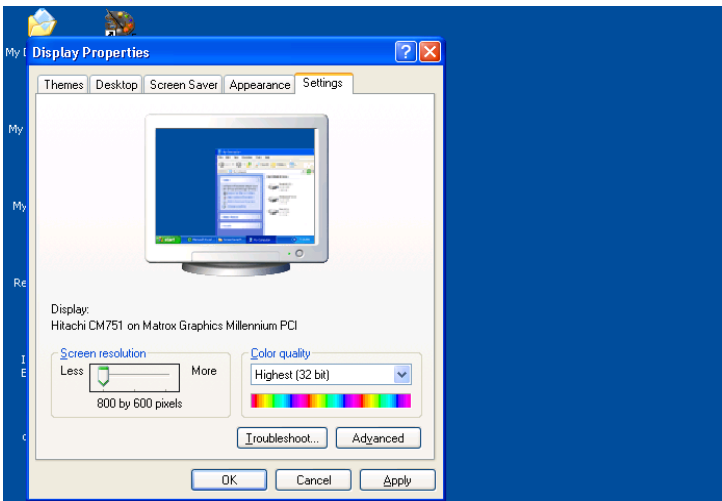

Sample Display Properties dialog box

- ❖ Click the **Settings** tab.
 - ❖ Slide the Screen area slider bar toward **Less** until the setting reads **800 x 600**.
 - ❖ Click **Apply**.
- 3 Press **FN+F5** four times.
 - 4 Start playing your movie or presentation

Playing DVDs

- 1 Open the DVD-ROM or DVD-ROM/CD-RW tray.
- 2 Place the DVD in the DVD-ROM or DVD-ROM/CD-RW drive.
- 3 Launch WinDVD™ and press the **Play** button.

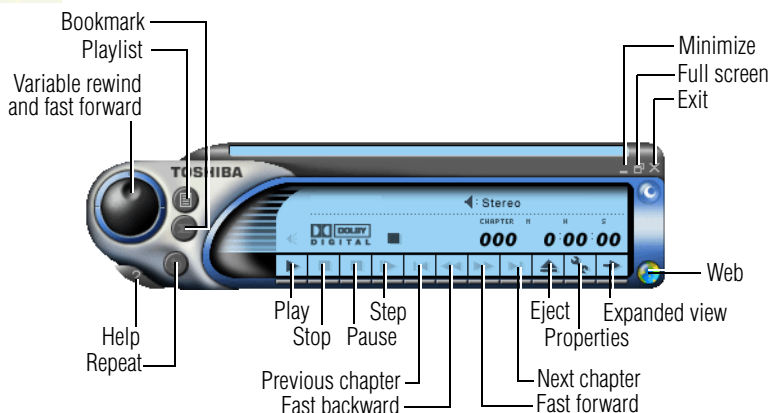

Sample WinDVD control panel

For more information about using WinDVD, see [“WinDVD” on page 179](#).

Exploring audio features

You can use your computer to record sounds using an external microphone. You can play .wav sound files or audio CDs using the built-in speakers, headphones or external speakers.

Recording sounds

You can make audio recordings and save them as .wav files by connecting an external microphone or other sound source

to the microphone jack and using the Sound Recorder feature in the operating system.



DEFINITION: A .wav (pronounced “wave”) file is the format for storing sound in files.

Using a microphone

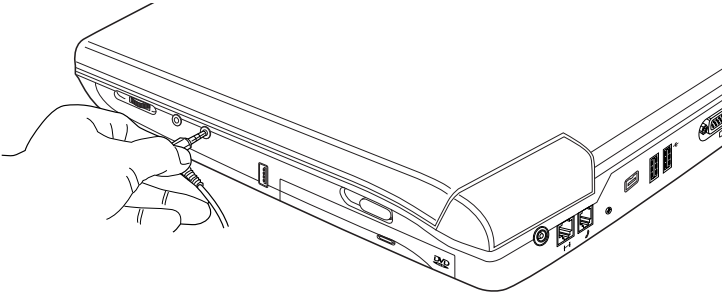

Attaching a microphone



- 1 Connect an external microphone to the computer.
- 2 Click **Start**, point to **All Programs, Accessories, Entertainment**, then click **Sound Recorder**.

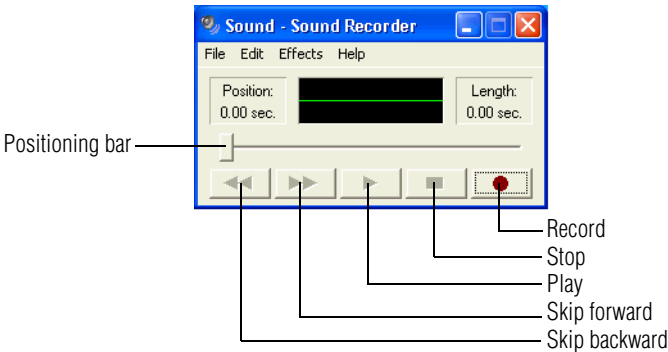

Sample Sound Recorder screen



- 3 Click the **Record** button and speak normally into the microphone.



NOTE: You can only record 60 seconds at a time.



- 4 When you have finished recording, click the **Stop** button.



- 5 To hear what you just recorded, click the **Play** button.

- 6 To save the file, select **Save** from the **File** menu.

Adjusting recording quality

The better the quality of the recording, the more disk space the sound file requires. Experiment to find a balance that fits your needs.

- 1 Open Sound Recorder, if necessary (click **Start**, point to **All Programs**, **Accessories**, **Entertainment**, then click **Sound Recorder**).
- 2 In the Sound Recorder window, click **Edit**, then click **Audio Properties**.
- 3 In the Audio Properties dialog box, adjust the Sound Playback quality and volume, and the Sound Recording volume.
- 4 Click **OK**.

Your new settings take effect the next time you record.

Using external speakers or headphones

Your computer is equipped with a full stereo sound system and internal speakers. Instead of using the internal speakers, you can connect headphones, a pair of external stereo speakers.



TECHNICAL NOTE: Use amplified speakers that require an external power source. Other types of speakers will be inadequate to produce sound from the computer.

To play back sound files through external speakers or headphones:



- 1 Locate the headphone jack on the right side of the computer.

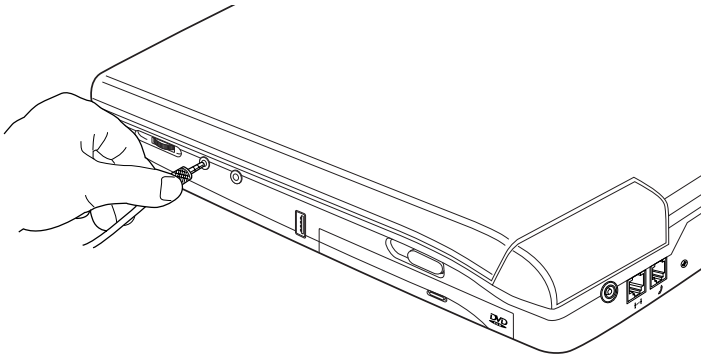

Attaching a headphone or speaker cable

- 2 Using any necessary adapters, plug the cable from the headphones or external speakers into the headphone jack. The out requires a 16-ohm stereo mini-jack.
- 3 Adjust the volume:
 - ❖ For external speakers, use the volume controls on each speaker.
 - ❖ For headphones, use the computer's volume control dial.

Using PC Cards

PC Cards expand your computer's capabilities and usefulness. You can purchase additional PC Cards from your dealer. Most PC Cards conform to the PCMCIA (Personal Computer Memory Card International Association) standard.

Your computer has two stacked PC Card slots and supports two types of PC Cards, known as types II and III:

- ❖ A Type II card is typically used for memory storage, as a network card, and so on. You can install two Type II cards.
- ❖ A Type III card is used for removable hard disks and other functions that require a larger card. You can install one of these cards.

Check the documentation that came with the PC Card to see if it conforms to the PCMCIA 2.1 standard, or later. Other cards may work with your computer, but are likely to be much more difficult to set up and use.

PC Card supporting software

The operating system provides the Card and Socket Services for your PC Card and is installed automatically. Even if your PC Card comes with its own version of Card and Socket Services, you should use the files included in the Windows® XP operating system.

Inserting PC Cards

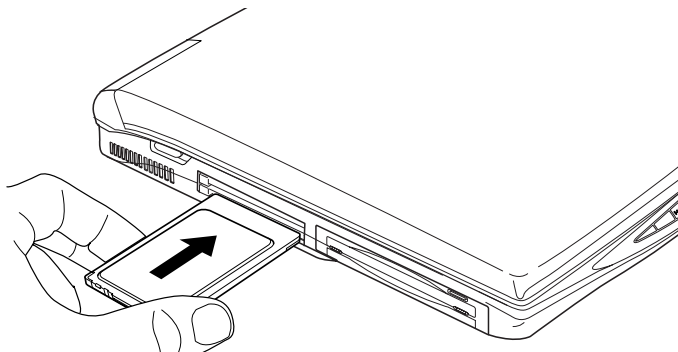

Inserting a PC Card

- 1 If your PC Card does not support hot swapping, save your data and turn off the computer before inserting the PC Card. For more information, see [“Hot swapping” on page 174](#).
- 2 Hold the PC Card with the arrow or main label side up and the connector side toward the slot.
- 3 Align the card connectors with an available PC Card slot and carefully slide the card into the slot until it locks into place.



NOTE: If you have a Type III card, insert the connector into the lower slot. If you have a Type II card, you can insert it into either the upper or the lower slot.

There are two eject buttons, one per slot.



CAUTION: To avoid damaging the PC Card or the computer, do not force the card into the PC Card slot.

Removing PC Cards

- 1 Click the **Safely Remove Hardware** icon on the taskbar.
- 2 Click **Safely remove xxxx**, where *xxxx* is the identifier for your PC Card.

The operating system advises you that you may safely remove the card.

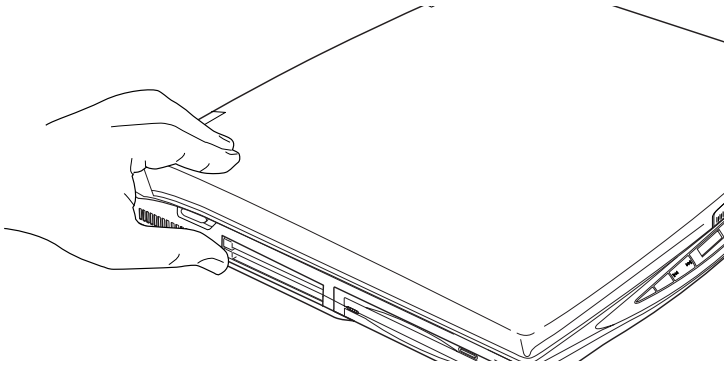

Ejecting a PC Card

- 3 Remove the PC Card and store it properly.

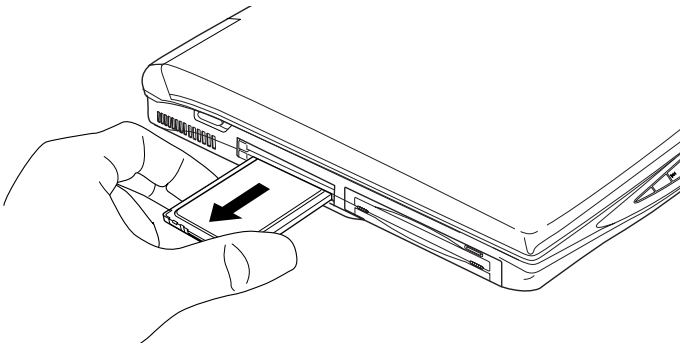

Removing a PC card

Hot swapping

One of the great things about PC Cards is that you can replace one PC Card with another while the computer is on. This is called “hot swapping.”

Hot swapping precautions

Although you can insert a PC Card at any time, to avoid data loss never remove a card while it is in use. For example:

- ❖ Never remove an ATA card while the system is accessing it.
- ❖ Never remove a network card while you are connected to a network.
- ❖ Never remove a SCSI card while any of the SCSI devices connected to it are operating.



DEFINITION: SCSI is an acronym for Small Computer Systems Interface. A single SCSI PC Card enables you to connect several SCSI devices, such as a scanner or digital camera to your computer.

Before removing a PC Card, shut it down by clicking the **Safely Remove Hardware** icon on the taskbar. Once the PC Card has stopped, you can safely remove it.

Chapter 7

Toshiba Utilities

Your computer includes several utilities designed to help you to reconfigure your system to best meet your individual needs. Together, these allow you to ascertain certain system details, set additional options, or change default options. These utilities are described in this chapter:

- ❖ Power Management

Power Management

The Power Management feature enables you to control your computer's power usage, regardless of the source, and use the many preset power modes, or define your own.

To access the Toshiba Power Management Utility.

- 1 Click **Start**, then click **Control Panel**.

The Control Panel appears.



- 2 Click the **Performance and Maintenance** icon.

- 3 Click the **Toshiba Power Management** icon.

The Toshiba Power Management Utility window appears.

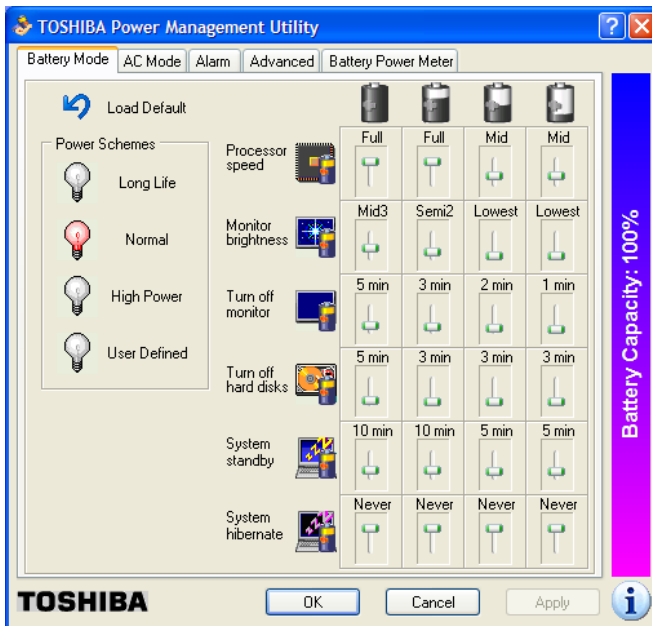

Sample TOSHIBA Power Saver Properties window

You may choose a power-saving management strategy to best suit your computing needs. If you are running on batteries and the programs that you are using do not require a lot of system resources, you may experience longer work sessions by enabling the Normal or Long Life settings.

By changing the options that appear in the Toshiba Power Saver Properties window and clicking **OK**, you can reconfigure that function. Any options that you change become effective when you click either **OK** or **Apply**.

AC mode tab

This section has two preset power usage mode — Full Power, and User Defined. Toshiba recommends use of the preset Full Power mode.

Battery mode tab

This section lists the preset modes along with the estimated battery life for each mode. The preset modes are:

- ❖ Long Life
- ❖ Normal
- ❖ High Power
- ❖ User Defined

Although you can change the properties for any of these modes, this is not recommended.

Chapter 8

WinDVD

WinDVD is a software program for playing back VideoCDs and DVDs. This chapter explains how to use this program.

Playing DVDs



TECHNICAL NOTE: For optimum DVD performance, always play DVDs while your computer is connected to AC power.

For systems with a DVD-ROM or DVD-ROM/CD-RW multifunction drive, you can use InterVideo WinDVD™ to play DVDs. WinDVD is an easy-to-use, full-featured multimedia control center that helps you get the most out of the exciting world of DVD technology. If your computer has a DVD-ROM or DVD-ROM/CD-RW multifunction drive, your computer comes with WinDVD preinstalled.

When you watch DVD movies on your computer using WinDVD, Toshiba highly recommends that your system's power management utility is set to full power mode.



WARNING: Before playing a DVD, turn down the volume. Playing the disc at maximum volume could damage your ears. See “Using the control panel playback buttons” on page 183 to locate the volume control buttons.

Fit the DVD-ROM or DVD-ROM/CD-RW drive into the Modular Bay. Insert a DVD into the drive, following the instructions in “Inserting a disc” on page 89. The computer automatically detects the disc in the drive and opens WinDVD. If the autoplay feature is enabled, the DVD automatically begins to play (see “Setting general properties” on page 189 for information on enabling autoplay).

To open WinDVD manually:

- 1 Click **Start**, and point to **All Programs**.
- 2 Point to **InterVideo WinDVD**, then click **InterVideo WinDVD**.



Sample WinDVD video window with the control panel

Using the WinDVD toolbar

The WinDVD window contains a toolbar at the top and a status bar at the bottom. If the toolbar or status bar does not appear, you can display them by following the instructions in [“Setting general properties” on page 189](#).

The toolbar contains basic DVD playback controls. Pause the pointer over a button to display its definition. The toolbar also contains an adjustment button (see [“Adjusting the color balance” on page 201](#) for more information).

Using the WinDVD status bar

The time slider enables you to rapidly move forward or backward in the DVD content. Move the time slider to the left to go backward or move it to the right to go forward. The current time slot is indicated on the right side of the status bar.

The playback speed slider enables you to control the speed at which the DVD plays. Move the slider to the left to slow the playback speed or move it to the right to play the DVD faster. Placing the slider in the center plays the DVD at normal speed, and enables the audio. The audio is automatically muted at any other playback speed.

The current chapter indicator displays the DVD chapter that is currently playing.

Using the WinDVD control panel

The WinDVD control panel resembles the control panel of a standard home DVD player.



TECHNICAL NOTE: The DVD author determines what features the DVD supports. Depending on the DVD format and your computer's hardware configuration, some of the control panel features may be unavailable when playing a DVD. Unsupported features appear gray, and you cannot select them.

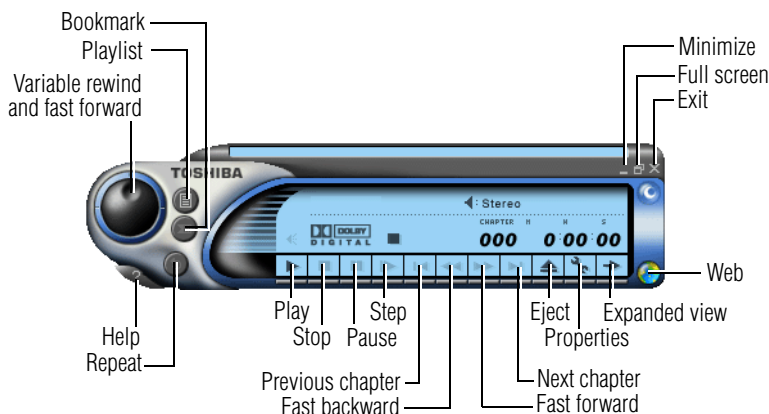

Sample WinDVD control panel

You can open a shortcut menu, by positioning the cursor over the WinDVD window, other than over the control panel, then clicking the secondary button. The shortcut menu contains the same features as the control panel, plus the enable caption feature, which displays captions for the hearing impaired.

You can also create a playlist, to customize the order in which the DVD content plays (see [“Creating playlists” on page 186](#)). Once a DVD is playing, the counter displays the current chapter and elapsed time, in *hours:minutes:seconds* format.





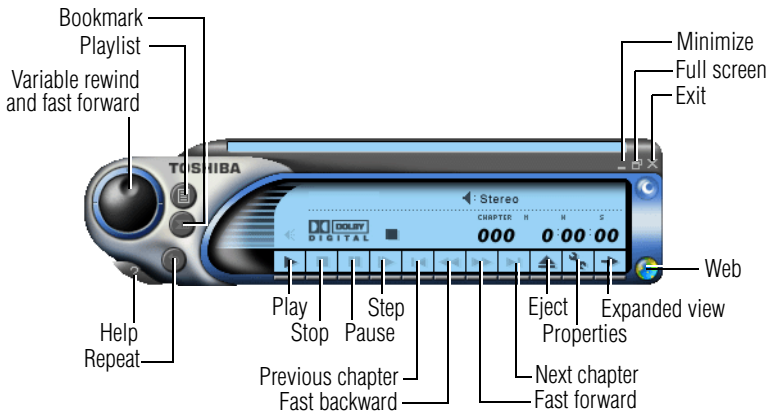

From the WinDVD control panel, you can open an expanded control panel by clicking the **expanded controls button**. The expanded control panel contains several advanced features. See “Using WinDVD Advanced Features” on page 195 for an explanation of these features.





Using the control panel playback buttons

Once you have inserted a DVD and started WinDVD, you are ready to play the disc. Using the control panel, you can play a DVD from the beginning, or move to a desired location then begin playing.



Sample WinDVD control panel

<i>Click this</i>	<i>To do this</i>	<i>Or use keyboard shortcut</i>
	Repeat — repeat the current chapter, if the DVD contains chapters. Otherwise this button repeats the DVD from the beginning. When the repeat button is activated, the repeat symbol appears to the left of the chapter number on the control panel counter. The DVD continues to repeat until you click the repeat button again, and the repeat symbol no longer displays on the control panel.	None
	Eject — open the DVD-ROM drive disc tray.	E
	Pause — temporarily stop playing a DVD.	Spacebar
	Play — start playing a DVD.	Spacebar
	Step — move forward through the DVD one frame at a time. Each time you click this button the DVD moves forward one frame.	None
	Stop — cease playing a DVD. After stopping the DVD, click the play button to resume playing the DVD.	End

<i>Click this</i>	<i>To do this</i>	<i>Or use keyboard shortcut</i>
	Fast backward — move quickly backward through the DVD content. When you reach the desired location, click the play button to resume playing the DVD.	R
	Previous — move to the beginning of the previous chapter and resume playing the DVD.	PgUp
	Next — move to the next chapter and resume playing the DVD.	PgDn
	Fast forward — move quickly forward through the DVD content. When you reach the desired location, click the play button to resume playing the DVD.	F
	Time — move to a specific time slot, then click the play button to play the DVD from the selected location.	None

Maximizing the video window



To close the WinDVD control panel and expand the video window to fill the screen, click the Maximize button.

To display the control panel again, double-click anywhere in the video window.

Using playlists



TECHNICAL NOTE: The DVD author determines what features the DVD supports. Depending on the DVD format and your computer's hardware configuration, some of the control panel features may be unavailable when playing a DVD. Unsupported features appear gray, and you cannot select them.

A playlist is a customized list of DVD files in the order in which you want to view them. For example, you may want to create a playlist for DVDs that contain music files, so you can play the music selections you want in the order you want to hear them. You can only save one playlist at a time.

Creating playlists



- 1 On the WinDVD control panel, click the playlist button. The Playlist window appears.

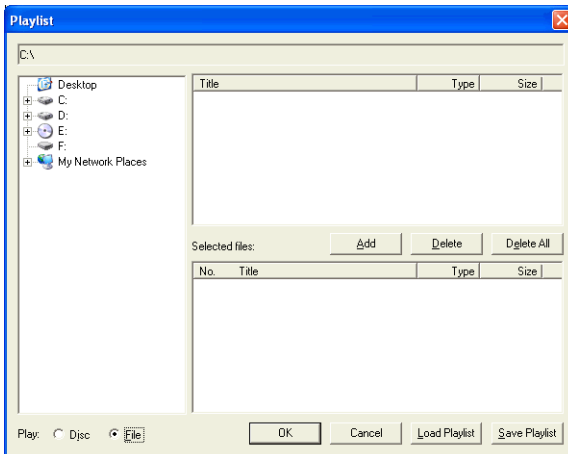

Sample Playlist window

-
- 2 Click the **File** button in the lower left corner of the window, to indicate that you are creating a playlist of individual files.
 - 3 In the left display select the drive and folder where the DVD files are located. In the upper right window, select the file you want to play first and click **Add** to put it at the top of the playlist.

DVD files have an .mpg, .vob or .ac3 file name extension. After selecting a file, the file name appears in the **Selected files** list. You can also double-click a file name to add it to the playlist.

- 4 Add as many files as you wish to the playlist. You must add the files in the order in which you want to play them.

To delete a file from the playlist, select the file in the **Selected files** list, then click **Delete**. To delete the entire list and start over, click **Delete All**.

- 5 When you have finished creating your playlist, click **Save Playlist** to save it.

You do not assign a name to the saved playlist, as you can only save one playlist at a time. After saving the playlist, a confirmation dialog box appears.

- 6 Click **OK** to close the confirmation dialog box, then click **OK** to close the **Playlist** window.

Loading and playing playlists

- 1 In the **Playlist** window, click **File** to display the saved playlist of files.

- 2 Click **Load Playlist** to load the saved playlist.

After loading the playlist, a confirmation dialog box appears.

- 3 Click **Open** to close the confirmation dialog box, then click **OK** to close the **Playlist** window.

The DVD begins to play the loaded playlist.

Resuming normal playback after using playlists

To resume playing the DVD files in order after using a playlist, click the eject button to open the disc tray, then close it again. The DVD resumes normal playback.

Customizing WinDVD

You can control several general WinDVD characteristics, such as whether the toolbar and status bar are visible, as well as numerous audio and display features.

You control **these general, audio and display features from the Properties dialog box.**

- 1 Launch WinDVD, if it is not already running.
- 2 On the WinDVD control panel, click the **Properties** button.

WinDVD displays the **Properties** dialog box, with the **General** tab on top.

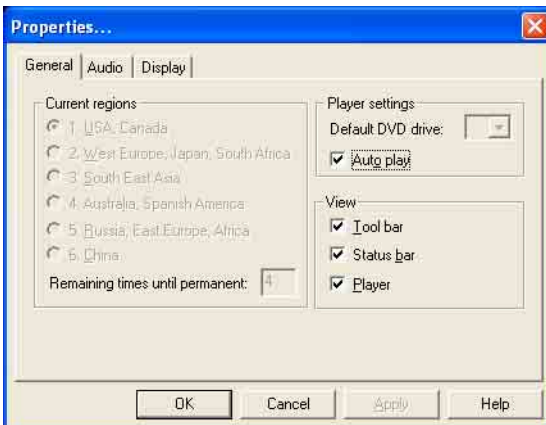

Sample Properties dialog box with the General tab on top

Setting general properties

You use the **General** tab to select the region code, the drive letter assigned to the DVD-ROM drive, the autoplay default option, and which WinDVD toolbars are displayed by default.

Region coding is part of the protection system for DVD content. It divides the world into six regions. The intent is to enable specific content to be viewed in a specific region. The current region code of the WinDVD player installed in your computer is Region 1, comprising the United States and Canada.



*NOTE: Most DVD-ROM drives let you change the region code, usually between one and five times. Once a drive has reached the limit, the region code cannot be changed again. Pay careful attention to the **Remaining times until permanent** box on the General properties tab.*

- 1 To change the region code, select the desired option in the **Current regions list**.

The **Remaining times until permanent** box displays the remaining number of times you can change the current region before the setting becomes permanent.

- 2 In the **Player settings Default DVD drive** box, select your DVD-ROM drive letter.
- 3 Select the **Player settings Auto play** check box to enable the auto play feature. Clear the check box to disable this feature.

When enabled, the auto play feature automatically launches a DVD-ROM when it is inserted in the DVD-ROM drive.

- 4 In the **View** box, select the items you want to display when WinDVD launches.

Tool bar is the bar containing basic player functions that is displayed at the top of the WinDVD video window.

Status bar is the bar that is displayed at the bottom of the WinDVD video window.

Player is the WinDVD control panel.

- 5 Click **OK** to save your settings.

Setting audio properties



NOTE: The DVD author determines which features the DVD supports. When playing a DVD, some of the control panel features may be unavailable. Unsupported features appear gray, and you cannot select them.

- 1 In the Properties dialog box, click the **Audio** tab.

The Audio tab moves to the front. The **Current audio track** box displays the current audio format and attributes.

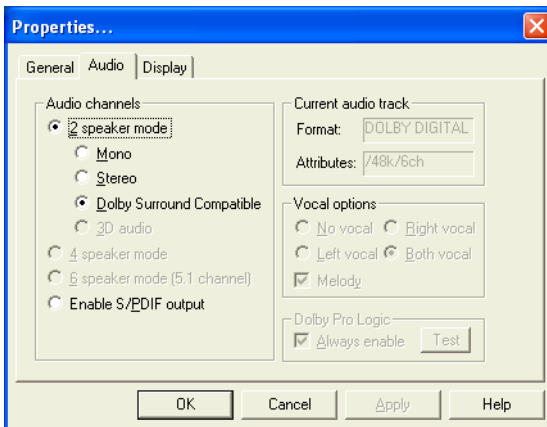

Sample Properties dialog box with Audio tab on top.

-
- 2 In the **Audio channels** box, select the appropriate speaker mode to match your setup as follows:
 - ❖ If you have two speakers, select one of the **2 speaker modes**. **Mono** mixes the audio channels into one channel. **Stereo** mixes the audio channels into two channels.
 - 3 In the **Vocal options** box, select the desired option for DVDs that support vocal as follows:
 - ❖ **No vocal** does not output vocals to any speaker.
 - ❖ **Left vocal** outputs vocals to left speakers only.
 - ❖ **Right vocal** outputs vocals to right speakers only.
 - ❖ **Both** outputs vocals to both left and right speakers.
 - 4 In the **Dolby Pro Logic** box, select the **Always enable** check box to enable Dolby Pro Logic. Clear the check box to disable it.
 - 5 To test Dolby Pro Logic, click the **Test** button.

Setting display properties

- 1 In the Properties dialog box, click the **Display** tab.
The **Display** tab moves to the front.

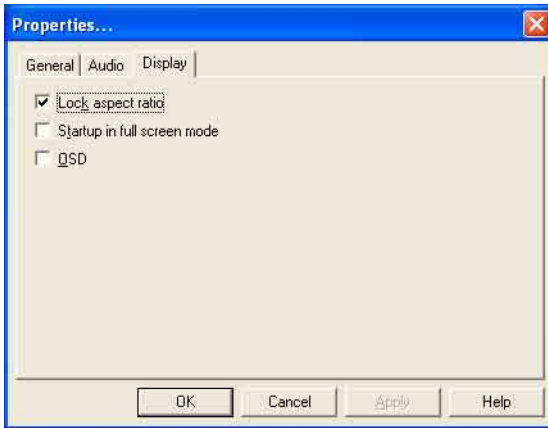

Sample Properties dialog box with Display tab selected

- 2 Select the **Lock aspect ratio** check box to maintain the original aspect ratio when the video window is resized. Otherwise clear the check box.
- 3 Select the **Startup in full screen mode** check box to automatically start WinDVD each time with the video window maximized and the control panel hidden. Otherwise, clear the check box.
- 4 Select the **OSD (On Screen Display)** check box to enable OSD. Otherwise, clear the check box.
- 5 Click **OK** to save the settings.

Customizing the control panel

You can customize the appearance of your WinDVD™ 2000 player's control panel.

To configure the control panel's appearance:

- 1 Position the pointer over the control panel, then click the secondary button to display a shortcut menu of control panel options.



Sample WinDVD control panel options

- 2 You can select a new control panel background color, or select **WinDVD** to display the control panel in a different format.



Sample new WinDVD control panel appearance

You can also select **About** to display copyright and version information.

Using WinDVD Advanced Features





TECHNICAL NOTE: The DVD author determines what features the DVD supports. Depending on the DVD format and your computer's hardware configuration, some of the control panel features may be unavailable when playing a DVD. Unsupported features appear gray, and you cannot select them.



The features described in this section are available on the WinDVD expanded control panel. To open the expanded control panel, click the expanded controls button on the WinDVD main control panel. See [“Playing DVDs” on page 179](#) for help locating the expanded controls button.





WinDVD expanded control panel

<i>Use this</i>	<i>To do this</i>	<i>Or use keyboard shortcut</i>
	<p>Playback speed— control the speed at which the DVD plays. Move the slider to the left to slow the playback speed or move it to the right to play the DVD faster. Placing the slider in the center plays the DVD at normal speed, and enables the audio. The audio is automatically muted at any other playback speed.</p>	None
	<p>Brightness — move the slider to the right to increase video brightness. Move it to the left to decrease brightness.</p>	+ (increases) - (decreases)
	<p>Directional buttons — use to navigate the WinDVD menus, as you would the arrow keys on the keyboard. The center button represents Enter.</p>	↑ (Up) → (Right) ↓ (Down) ← (Left) Enter

<i>Use this</i>	<i>To do this</i>	<i>Or use keyboard shortcut</i>
	<p>Numeric keypad — use these buttons to select a chapter by entering the chapter number. After you have entered a chapter number, click the check mark button on the right of the middle row on the numeric keypad to begin playing that chapter. You can clear an entry by clicking the clear (X) button on the lower left corner of the numeric keypad.</p>	0 - 9
	<p>Menu button — displays all available menus for the current DVD. Examples of menus are: Root, Audio Language, Subtitles. Use your mouse or the control panel directional buttons to select a menu. Click Resume to resume DVD playback.</p>	None

<i>Use this</i>	<i>To do this</i>	<i>Or use keyboard shortcut</i>
	Chapter button — displays a list of all the chapters in the current DVD. Select the chapter you want to play, or use the numeric keypad to enter the chapter number.	C
	Title button — Displays a list of all the titles on the current DVD. Click the title you want to play, then click Enter .	T
	Audio tracks — displays a list of all the audio track options. This feature is most commonly used with multi-language content to change the spoken/heard language. This button is enabled only when the DVD supports dynamic audio track changes.	A

<i>Use this</i>	<i>To do this</i>	<i>Or use keyboard shortcut</i>
	Subtitles — displays a list of all the available language subtitles. This button is enabled only for DVD content that includes subtitles and supports dynamic subtitle information changes. Select the desired language, or select Default to display subtitles in the DVD's default language.	S
	Camera angles — display a list of all the available camera angles. Due to differences in the DVD mastering process, some multi-angle views may not function properly.	G

Use this	To do this	Or use keyboard shortcut
	<p>Bookmark — save an unlimited number of locations on the DVD for quick reference. On the bookmark shortcut menu, click Add to open the Add Bookmark dialog box. Type a bookmark name, then click OK. The bookmark name appears on the bookmark shortcut menu. Click the bookmark name to go to that location on the DVD. Click Delete All to delete all bookmarks.</p>	None

Zooming in

You can zoom in on an area of the WinDVD video window to get a closer look.



- 1 Click the Zoom button, located in the upper-left corner of the directional button panel.
- 2 Position the cursor over the top-left corner of the area you want to view in close up.
- 3 Hold the primary button and drag the cursor to the bottom-right corner of the area you want to view in close up.

A dotted rectangle appears around the area you wish to view.

- 4 Release the primary button.

WinDVD automatically fills the window with the selected area.

Panning

Once you are zoomed in on an area of the WinDVD video window, you can move the zoom window location using the pan feature.



- 1 With the video window in zoom mode, click the pan button, located in the lower-right corner of the directional button panel.
- 2 With the pointer over the center of the window, drag the zoomed window up, down, left or right.

The close-up view changes to reflect the new zoom window location.

Zooming out



To return the video to normal size, click the zoom button. The video also returns to normal size when you reach the zoom limit.

Adjusting the color balance



You can adjust the DVD color balance. Click the adjustment button on the main DVD video window toolbar to open the Adjustment dialog box.

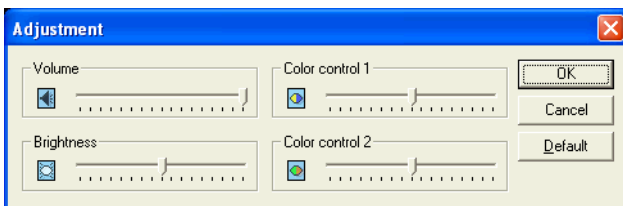

WinDVD Adjustment dialog box

The adjustment dialog box provides another set of sliders for adjusting volume and brightness. It also provides two color control sliders.

Move the **Color control 1** slider to the right to increase the blue and decrease the yellow color values. Move the slider to the left to increase the yellow and decrease the blue color values.

Move the **Color control 2** slider to the right to increase the red and decrease the green color values. Move the slider to the left to increase the green and decrease the red color values.

Launching an Internet browser from WinDVD



Some DVDs contain links to Web sites. To enable these links, click the control panel Web button to launch your Internet browser.

Getting Help



Click the control panel Help button to open the WinDVD Help system.

Exiting WinDVD



Click the control panel Exit button, or click the Close button, to exit WinDVD.

Chapter 9

If Something Goes Wrong

Some problems you may encounter when using your notebook computer are relatively easy to identify and solve. Others may require help from your dealer or the manufacturer of a software program.

This chapter aims to help you solve many problems by yourself. It covers the problems you are most likely to encounter.

If all else fails, contact Toshiba. You will find information on Toshiba's support services at the end of this chapter.

Problems that are easy to fix

Your program stops responding.

If you are working with a program that suddenly freezes all operations, chances are the program has stopped responding. You can exit the failed program without shutting down the operating system or closing other programs.

To close a program that has stopped responding:

- 1 Press Ctrl, Alt, and Del simultaneously (once).
- 2 Click **Windows Task Manager**.

The Windows Task Manager window appears.

- 3 Click the **Applications** tab.

If a program has stopped responding, the words “not responding” appear beside its name in the list.

- 4 Select the program you want to close, then click **End Task**.

Closing the failed program should allow you to continue working. If it does not, continue with step 3.

- 5 Close the remaining programs one by one by selecting the program name, then **End Task**.

- 6 Click **Start, Turn off computer**.

- 7 The Turn off computer window appears.

- 8 Click **Turn off**.

The computer turns off.

Your program performs an illegal operation.

If you receive the message, “Your program has performed an illegal operation,” you should record the details of the message and consult the software manufacturer.

To record the details:

- 1 Click the **Details** button and select the text the operating system displays.

The Details button displays information that the software manufacturer needs to help you solve your problem.

- 2 Press Ctrl and c simultaneously to copy the text to the clipboard.

- 3 Open Notepad (click **Start**, point to **All Programs**, then point to **Accessories** and click **Notepad**).

- 4 Press Ctrl and v simultaneously to paste the details into Notepad.
- 5 Add a paragraph break and type some notes describing what you were doing when you received the message.
- 6 Save the file and refer to it when you contact the software manufacturer.

Problems when you turn on the computer

These problems may occur when you turn on the power.

The computer will not start.

Make sure you attached the AC adapter and power cable properly or installed a charged battery.

Press and hold down the power button for a few seconds.

If you are using the AC adapter, check that the wall outlet is working by plugging in another device, such as a lamp.

The computer starts but, when you press a key, nothing happens.

You are probably in Stand By mode and have a software or resource conflict. When this happens, turning the power on returns you to the problem instead of restarting the system. To clear the condition, press Ctrl, Alt, and Del simultaneously.

Clearing the condition may get the computer running, but it won't solve a resource conflict. Read the documentation that came with the conflicting device and [“Resolving a hardware conflict” on page 209](#).

The computer is not accessing the hard disk or the diskette drive.

Your computer normally loads the operating system from the hard disk. If you have a hard disk problem, you will not be able to start the computer. Insert a system diskette into the

external diskette drive and press the left or right arrow key and choose your boot-up device.



HINT: Press F12 as you power on the computer to access the menu.

The computer displays the WARNING RESUME FAILURE message.

The computer was placed in Stand By mode and the battery has discharged. Data stored in the computer's memory has been lost.

To charge the battery, leave the computer plugged into a live wall outlet for several hours. For more information, see [“Power and the batteries” on page 213.](#)

The computer displays the Non-System disk or disk error message.

Make sure there is no diskette in the diskette drive. If there is one, remove it and press any key to continue. If pressing any key does not work, press Ctrl, Alt, and Del to restart the computer.

The Windows® operating system is not working

Once you are familiar with the desktop and used to the way the operating system responds to your work routine, you can easily detect if the operating system is not working correctly. For example:

- ❖ The operating system fails to start after the Starting Windows XP message appears.
- ❖ The operating system takes a long time to start.
- ❖ The operating system responds differently from the normal routine.
- ❖ The screen does not look right.

Unless a hardware device has failed, problems usually occur when you change the system in some way such as installing a new program or adding a device.

If you experience any of these problems, use the options in the Startup menu to fix the problem.

Using Startup options to fix problems

If the operating system fails to start properly, you may have to change your system's configuration or verify the startup procedure to fix the problem. To do this, use the options in the Startup menu. This section describes each option and when to use the procedure.

To open the Startup menu:

- 1 Restart your computer.
- 2 Press F8 when your computer starts.

The Windows® Advanced Options menu displays these options:

- ❖ Safe Mode
- ❖ Safe Mode (with Networking)
- ❖ Safe Mode (with Command Prompt)
- ❖ Enable Boot Logging
- ❖ Enable VGA Mode
- ❖ Last known good configuration (your most recent settings that worked)
- ❖ Directory Services Restore Mode (Windows® domain controllers only)
- ❖ Debugging Mode
- ❖ Start Windows® normally
- ❖ Reboot
- ❖ Return to OS Choices (menu)

See your Windows® documentation for further explanation.



TECHNICAL NOTE: If your computer is connected to a network, the Startup menu may display different versions of Safe mode.

Internet problems

My Internet connection is very slow.

Many factors contribute to the speed with which you can surf the Internet. They include: modem speed, time of day (when everyone else is surfing, your access can be slow) and popularity of the site. If accessing a particular site is very slow, try later.

My browser can't find the URL address I typed in.

Make sure you separated the domain names of the address with the forward slash (/). Check the spelling of each name and the syntax of the address carefully. A single incorrect letter or missed character, comma instead of period (“dot”) or other mistake makes it impossible for your browser to locate the site.

My browser can't find a site I bookmarked.

The World Wide Web is constantly changing. A site you bookmarked yesterday may not be available today or its server may be down for temporary repair. Try again later.

The Windows® XP operating system can help you

If the operating system has started properly, but you still have a problem using your computer, the online Help can assist you in troubleshooting the problem.

To access Windows® XP Help and Support:

- 1** Click **Start**, then click **Help and Support**.

The Help and Support window appears.

- 2 Then do one or both of the following:
 - ❖ In the search field, type in the topic of the problem with which you need help and follow the on-screen instructions.
 - ❖ Click a problem you would like help with from the listings and follow the on-screen instructions.

You can connect to Support Online by clicking **Support** from the menu.

Resolving a hardware conflict

If you receive an error message telling you there is a device driver conflict or a general hardware problem, try using Windows® Help and Support to troubleshoot the problem first.

For help on hardware conflicts:

- 1 Click Start, then click **Help and Support**.
- 2 Click the **Hardware** link in the window's left pane.
A list of category links appear.
- 3 Click the **Fixing a hardware problem**.
- 4 Choose from specific topics and follow the steps.

If there is still a problem, the operating system should display a message that explains what the conflict is.

A plan of action

The smooth operation of the system depends on the interaction of all devices, programs, and features. If the system or one of its attached devices isn't working, resolving the problem can be time-consuming and frustrating.

The recommended procedure for getting multiple devices to work together is to add and set up one device at a time. After you add each device, test it to make sure it and all previously connected devices work.

The device most recently connected to the system is the one most likely to be causing a hardware conflict.

Resolving hardware conflicts on your own

Computer components need resources to accomplish a task. A device, such as a disk drive or a modem, needs a channel to the computer's Central Processing Unit (CPU). It also needs a direct channel to the computer's memory to store information as it works. These channels of communication are commonly referred to as system resources.

Interrupt Request Channel

The channel to the CPU is called an Interrupt Request (IRQ) because it interrupts what the processor is doing and requests some of the processor's time. If two or more devices use the same IRQ, the processor does not know which device is asking for attention. This causes a hardware conflict.

Direct Memory Access

Similarly, the data required by the device is stored in a specific place or address in memory called the Direct Memory Access (DMA). The DMA provides a dedicated channel for adapter cards to bypass the microprocessor and access memory directly. If two or more devices use the same DMA, the data required by one device overwrites the data required by the other, causing a hardware conflict.

Resolving conflicts

There are three things you can do to resolve hardware conflicts:

- ❖ Disable the device.
For an older device, remove it from the computer.
- ❖ Disable another system component and use its resources for the new device, see [“Fixing a problem with Device Manager”](#) on page 211.

-
- ❖ Reconfigure the device so that its requirements do not conflict. Refer to the device's documentation for instructions about changing settings on the device.

Fixing a problem with Device Manager

Device Manager provides a way to check and change the configuration of a device.



CAUTION: Changing the default settings using Device Manager can cause other conflicts that make one or more devices unusable. Device Manager is a configuration tool for advanced users who understand configuration parameters and the ramifications of changing them.

Disabling a device

- 1 Click **Start, Control Panel**, and then **Performance and Maintenance**.
- 2 Click the **Computer Management** icon.
- 3 Click **Device Manager** in the left frame.
- 4 Select the specific device from the device category.
- 5 In the toolbar, look to the far right for an icon of a monitor with a strike mark through a circle on the front. This is the disable feature.
- 6 Click the icon.
You are given the option of disabling the device.
- 7 Click **yes** or **no**, whichever is appropriate.

Checking device properties

Device Manager provides a way to view the properties of a device. Properties include the name of the manufacturer, the

type of device, the drivers installed, and the system resources assigned to the device.

To check a device's properties:

- 1** Click **Start, Control Panel, Performance and Maintenance**, and then **Administrative Tools**.
- 2** Click the **Computer Management** icon.
- 3** Click the **Device Manager** button.
- 4** To view the device(s) installed, double-click the device type.
- 5** To view the properties, double-click the device.

The operating system displays the Device Properties dialog box, which provides an array of tabs. They include:

- ❖ The **General** tab, which provides basic information about the device.
- ❖ The **Resource** tab, which lists resources assigned to the monitor, DVD-ROM, DVD-ROM/CD-RW, diskette drive, and other power-using functions.
- ❖ The **Drivers** tab, which displays the drivers being used by the device.

A Troubleshooting button is also present.

Click **troubleshooting**.

A Help and Support window for that device appears.

For more information about Device Manager, refer to Windows® XP online help.

- ❖ The **Resource** tab, which lists resources assigned to the monitor, DVD-ROM, DVD-ROM/CD-RW, diskette disk drive, and other power-using functions.
- ❖ The **Drivers** tab, which displays the drivers being used by the device.

Memory card problems

Incorrectly connected or faulty memory modules may cause errors that seem to be device-related. It is worthwhile checking for these first:

1 Click **Start**, then click **Turn Off Computer**.

2 Click **Turn Off**.

The operating system shuts down and turns off the computer automatically.

3 Remove the memory module.

4 Reinstall the memory module, following the instructions in “[Installing additional memory \(optional\)](#)” on page 57, and making sure it is seated properly.

5 Check for the error again.

6 If the error recurs, remove the memory module entirely and check for the error again.

If removing the memory module eliminates the error, the memory module may be faulty. If the error recurs without the memory module installed, the error is not caused by the memory module.

Power and the batteries

Your computer receives its power through the AC adapter and power cable or from the system batteries (main battery and real-time clock (RTC) battery). Power problems are interrelated. For example, a faulty AC adapter or power cable will neither power the computer nor recharge the batteries.

Here are some typical problems and how to solve them:

The AC power light does not come on when you plug in the AC adapter and power cable.

Make sure the AC adapter and power cable are firmly plugged into both the wall outlet and the computer.

If the AC power light still does not come on, check that the wall outlet is working properly by plugging in a lamp or other appliance.

The AC adapter and power cable work correctly, but the battery will not charge.

The battery doesn't charge while the computer is consuming full power. Try turning off the computer.

The main battery may not be inserted correctly in the computer. Turn off the computer, remove the battery, clean the contacts with a soft dry cloth (if necessary) and replace the battery.

The battery may be too hot or too cold to charge properly. If you think this is the probable cause, let the battery reach room temperature and try again.

If the battery has completely discharged, it will not begin charging immediately. Leave the AC adapter and power cable connected, wait 20 minutes and see if the battery is charging.

If the battery light is glowing after 20 minutes, let the computer continue charging the battery for at least another 20 minutes before you turn on the computer.

If the battery light does not glow after 20 minutes, the battery may have reached the end of its useful life. Try replacing it.

The battery appears not to power the computer for as long as it usually does.

If you frequently recharge a partially charged battery, it may not charge fully. Let the battery discharge completely, then try charging it again.

Check the power options using the Power Management utility. Have you added a device, such as a PC Card or memory module, that takes its power from the battery? Is your software using the hard disk more? Is the display power set to turn off automatically? Was the battery fully charged to begin with? All these conditions affect how long the charge lasts.

For more information on maximizing battery power, see “Charging batteries” on page 109.

Keyboard problems

If, when you type, strange things happen or nothing happens, the problem may be related to the keyboard itself.

The keyboard produces unexpected characters.

A keypad overlay may be on. If the numeric keypad or cursor control light is on, press Fn and F10 simultaneously to turn off the cursor control light or press Fn and F11 simultaneously to turn off the numeric keypad light.

If the problem occurs when both the keypad overlays are off, make sure the software you are using is not remapping the keyboard. Refer to the software’s documentation and check that the program does not assign different meanings to any of the keys.

You have connected an external keyboard and the operating system displays one or more keyboard error messages.

If you have a second keyboard, try it. If it works, the first keyboard may be defective or incompatible with your computer.

Display problems

Here are some typical display problems and their solutions:

The display is blank.

Display Auto Off may have gone into effect. Press any key to activate the screen.

You may have activated the instant password feature by pressing Fn and F1 simultaneously. If you have registered a password, press the Enter key, type the password and press Enter. If no password is registered, press Enter. The screen reactivates and allows you to continue working.

If you are using the built-in screen, make sure the display priority is not set for an external monitor. To do this, press Fn and F5 simultaneously (once). If this does not correct the problem, press Fn and F5 simultaneously again to return the display priority to its previous setting.

If you are using an external monitor:

- ❖ Check that the monitor is turned on.
- ❖ Check that the monitor's power cable is firmly plugged into a working power outlet.
- ❖ Check that the cable connecting the external monitor to the computer is firmly attached.
- ❖ Try adjusting the contrast and brightness controls on the external monitor.
- ❖ Press Fn and F5 simultaneously to make sure the display priority is not set for the built-in screen.

The screen does not look right.

You can change the display settings by clicking a blank area of the desktop with the secondary control button, then clicking Properties. This opens the Display Properties dialog box. The Appearance tab of this dialog box allows you to choose the colors for the screen. The Settings tab allows you to choose the screen resolution.

The built-in screen flickers.

Some flickering is a normal result of the way the screen produces colors. To reduce the amount of flickering, try using fewer colors.

To change the number of colors displayed:

- 1** Point at the desktop and click with the secondary button.
- 2** Click **Properties**, and then the **Settings** tab.
- 3** Change the Colors option and click **OK**.

For more information, see Windows[®] Help.

A message tells you that there is a problem with your display settings and that the adapter type is incorrect or the current settings do not work with your hardware.

Reduce the size of the color palette to one that is supported by the computer's internal display.

To change the display properties:

- 1 Point at the desktop and click with the secondary button. The Display Properties window appears.
- 2 Click **Properties**, then click the **Settings** tab.
- 3 Adjust the screen resolution and/or color quality.
- 4 Click **OK**.

The display mode is set to Simultaneous and the external display device does not work.

Make sure the external monitor is capable of displaying at resolutions of 800 x 600 or higher. Devices that do not support this resolution will only work in Internal/External mode.

Disk drive problems

Problems with the hard disk or with a diskette drive usually show up as an inability to access the disk or as sector errors. Sometimes a disk problem may cause one or more files to appear to have garbage in them. Typical disk problems are:

You are having trouble accessing a disk, or one or more files appear to be missing.

Make sure you are identifying the drive by its correct name (A: or C:).

Error-checking

Run Error-checking, which analyzes the directories, files and File Allocation Table (FAT) on the disk and repairs any damage it finds:

To run Error-checking:

- 1** Click **Start**, then click **My Computer**.
- 2** Right-click the drive you want to check.
The drive's properties box appears.
- 3** Click the **Tools** tab.
- 4** Click the **Check now** button.
The Check Disk All Apps box appears.
- 5** You can choose one or both options:
 - ❖ Automatically fix file system errors
 - ❖ Scan for and attempt recovery of bad sectors
- 6** Click **Start**.
Error-checking runs the test.

Your hard disk seems very slow.

If you have been using your computer for some time, your files may have become fragmented. Run Disk Defragmenter. To do this, click **Start**, then click **All Programs**, point to **Accessories** and **System Tools**, and click **Disk Defragmenter**.

Your data files are damaged or corrupted.

Refer to your software documentation for file recovery procedures. Many software packages automatically create backup files.

You may also be able to recover lost data using utility software, which is available from your dealer.

Some programs run correctly but others do not.

This is probably a configuration problem. If a program does not run properly, refer to its documentation and check that the hardware configuration meets its needs.

A diskette will not go into the external diskette drive.

You may already have a diskette in the drive. Make sure the drive is empty.

You may be inserting the diskette incorrectly. Hold the diskette with the hub side facing down, and insert it so that the metal head window cover goes into the drive first.

The metal cover or a loose label may be obstructing the path into the drive. Carefully inspect the diskette. If the metal cover is loose, replace the diskette. If the label is loose, replace the label and try inserting the diskette again.

The computer displays the Non-system disk or disk error **message.**

If you are starting the computer from a diskette, the diskette in the drive does not have the files necessary to start the computer. Replace it with a bootable diskette.

The drive cannot read a diskette.

Try another diskette. If you can access the second diskette, the first diskette (not the drive) is probably causing the problem. Run Error-checking on the faulty diskette (for instructions, see [“Disk drive problems” on page 217](#)).

DVD-ROM or DVD-ROM/CD-RW drive problems

You cannot access a disc in the drive.

Make sure the drive tray has closed properly. Press gently until it clicks into place.

Open the drive tray and remove the disc. Make sure the drive tray is clean. Any dirt or foreign object can interfere with the laser beam.

Examine the disc to see whether it is dirty. If necessary, wipe it with a clean damp cloth dipped in water or a neutral cleaner.

Replace the disc in the tray. Make sure it is lying flat, label side upmost. Press the disc down until it locks on the

spindle. Close the drive tray carefully, making sure it has shut completely.

You press the disc eject button, but the drive tray does not slide out.

Make sure the computer is connected to a power source and turned on. The DVD-ROM or DVD-ROM/CD-RW drive eject mechanism requires power to operate.

To remove a disc without turning on the computer, use a narrow object, such as a straightened paper clip, to press the manual eject button. This button is in the small hole next to the disc eject button on the right side of the computer.

Some discs run correctly, but others do not.

If the problem is with an application CD-ROM, refer to the software's documentation and check that the hardware configuration meets the program's needs.

The color of the materials used to make the disc can affect its reliability. Silver-colored CD-ROMs are the most reliable, followed by gold-colored CD-ROM. Green-colored CD-ROMs are the least reliable.

WinDVD problems: general issues

WinDVD™ has been configured to provide optimum performance and quality based upon your system's available resources. Changes made to the system or its configuration may impact the playback performance of the WinDVD player.

WinDVD controls are disabled.

Controls may be grayed out by commands on the DVD disc. For example, it is common for DVD movie titles to disable fast-forward and rewind during the legal notices at the beginning of a movie.

Playback performance is poor.

Make sure your system's A/C adaptor is plugged in and the system's power setting is on full.

The Root or Title menu does not open.

Most DVD titles have one or both of the "Root" and "Title" menus. If one menu button appears to do nothing, try the other menu button.

WinDVD performance decreases after making a system change.

DVD playback performance is dependent upon several system resources. Changes to these system resources caused, for example, by installing a new graphics or audio card may impact performance. Some software changes may also impact playback performance (for example, downloading new drivers from the Web).

Before installing a new hardware or software component on your system, check for any potential conflicts between its resource requirements and your current system configuration. Also, if you change your operating system, check with your PC manufacturer or your graphics card vendor to ensure that you have the appropriate drivers for both your hardware (for example, the graphics card) and software (drivers must support the operating system and DVD with WinDVD).

Slow playback performance.

DVD playback is a resource intensive application. Other applications and/or changes to your system hardware, software or configuration can impact playback performance. If playback is slower than normal, try:

- 1** Closing any other open applications to improve the performance of the DVD playback.
- 2** Ensuring DMA (Direct Memory Access) is turned on.

See "[Secondary IDE Channel DMA setting](#)" on page 222 for more information.

- 3 If you have installed new hardware, ensure the component's drivers support Microsoft® DirectX® 8.1 or higher and WinDVD. Contact the manufacturer of the component.
- 4 Verifying that your display driver resolution, color depth and refresh rate are optimal for DVD playback. (Some systems do not support video overlays if these parameters are not optimal.) Try lowering these settings to improve performance.

Secondary IDE Channel DMA setting

To ensure the Secondary IDE Channel DMA setting:

- 1 Click **Start, Control Panel**, then **Printers and Other Hardware**.
- 2 Click the **System** icon.
The System Properties window displays.
- 3 Click the **Hardware** tab.
- 4 Click the **Device Manager** button
- 5 Click "+" to open the IDE ATA/ATAPI Controllers.

- 6 Double-click the **Secondary IDE Channel** icon.
The Secondary IDE Channel Properties window displays.

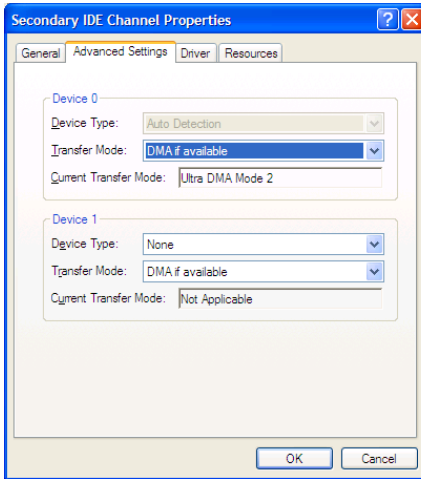

Sample Secondary IDE Channel Properties window

- 7 Click **Advanced Settings**.
- 8 Look at Device 0. The current transfer mode should be Ultra DMA Mode 2. If it isn't, select Ultra DMA Mode 2 from the drop-down list and click **OK**.

WinDVD problems: content issues

Movies exhibit poor performance of “Director's Commentary” or other similar optional content versions.

Some movies may exhibit poor performance of these features. In particular, the video portion of the movie may become jerky or show pauses. The normal version of the movie will not show this problem.

WinDVD will not function properly with “debug” software installed.

The WinDVD application will not function properly if it detects that debug software is present on the system. Remove the debug software to restore functionality of WinDVD.

Minimum system requirements

WinDVD performs best when these recommended components are present in your system:

- ❖ Sound card (with 48 KHz sampling rate support)
- ❖ DirectX® 8.1 or higher (Source: Microsoft)
- ❖ DVD-ROM drive with DMA enabled (only available with Microsoft OSR 2.1 or above with PIXX 4.0 and USB support added)
- ❖ WinDVD software

WinDVD: error messages

This table offers descriptions and resolutions for error messages that may appear when using WinDVD.

<i>Error message and additional information</i>	<i>Resolution</i>
The disc in the DVD-ROM drive is not a valid disc type. Valid disc types are DVD-Video and audio CD.	Ensure the disc is a valid disc type. If the disc works in other players, try using a disc cleaner. The disc may require features that are not supported by WinDVD.

<i>Error message and additional information</i>	<i>Resolution</i>
<p>Microsoft® DirectShow® components are missing.</p> <p>Microsoft® DirectShow® is not installed properly on the system.</p>	<p>Reinstall Microsoft® DirectShow® version 6.0 or higher (available from the Microsoft Web site).</p>
<p>No audio subsystem could be found for playback.</p> <p>There is a problem with the audio card or audio component within the system. The problem may be one of the following:</p> <p>There is a problem with the audio driver.</p> <p>The audio card is faulty.</p>	<p>Check installation of the sound card drivers.</p>
<p>WinDVD cannot display the selected resolution due to system limitations.</p> <p>The screen size exceeds the allowable display limit.</p> <p>There are not enough system resources to play the DVD at the selected setting.</p>	<p>Alter the display settings to reduce the resolution or number of colors.</p> <p>Update video drivers.</p>

<i>Error message and additional information</i>	<i>Resolution</i>
<p>The audio settings are incorrect. Please check sound card or drivers.</p> <p>The audio card was found, but there is a problem with the audio card or drivers. The wrong audio driver may be installed in the system.</p>	<p>Check installation of the audio card drivers.</p>
<p>An unexpected error has occurred.</p> <p>This error is unclassified. Report the problem and any error code to your supplier's Technical Support.</p>	<p>This is usually a rare, title-specific problem.</p>
<p>There is a problem with the copy protection system within the DVD-ROM drive. Playback cannot continue.</p> <p>The DVD-ROM drive failed to authenticate (authorize playback of) the DVD disc. There may be a problem with the DVD-ROM drive.</p>	<p>Try to play another disc. Contact your supplier's Technical Support.</p>
<p>WinDVD does not support this version of the DVD specification.</p>	<p>Check that this is a DVD-Video 1.0 disc.</p>

<i>Error message and additional information</i>	<i>Resolution</i>
<p>This DVD disc cannot be played in this region.</p> <p>The selected region cannot be used due to one of the following:</p> <p>The Region Code of WinDVD and the DVD disc do not match. Check the Region Code of WinDVD within the About tab and use a disc from the appropriate region.</p> <p>The Windows operating system is assigned to a region that does not match the Region Code of WinDVD.</p>	<p>Use DVD content from the appropriate region. If applicable on your system, refer to the Help file for how to change the Region Code.</p>
<p>Permission to play is denied. Please check the Parental Control setting.</p> <p>The Parental Control setting of WinDVD is lower than the Parental Control level of the content being played. Playback of the DVD disc is not authorized.</p>	<p>Change the Parental Control level in the DVD Options dialog. Note that WinDVD requires a password for this change.</p>
<p>WinDVD encountered an error.</p>	<p>Report the problem and any error code to your supplier's Technical Support.</p>

<i>Error message and additional information</i>	<i>Resolution</i>
This file appears to contain unsupported data.	Please refer to the Supported Formats section of the WinDVD Help file and ensure that this file contains valid data.
The drive or disc cannot be found. This may be caused by one of the following: No disc in the DVD-ROM drive. No DVD-ROM drive. A disc of an unsupported type in the DVD-ROM drive.	Check the DVD-ROM drive or DVD disc. Ensure the disc is a valid type (DVD-Video, Video CD, or audio CD).

Sound system problems

You do not hear any sound from the computer.

Adjust the volume control.

If you are using external headphones or speakers, check that they are securely connected to your computer.

The computer emits a loud, high-pitched noise.

This is feedback between the microphone and the speakers. It occurs in any sound system when input from a microphone is fed to the speakers and the speaker volume is too loud. Adjust the volume control.

Changing the settings for the Record Monitor feature in the Recording Control Utility (default Off), or the Mute feature

in the Mixer Utility (default Enabled), may cause feedback. Revert to the default settings.

PC Card problems

PC Cards (PCMCIA-compatible) include many types of devices, such as a removable hard disk, additional memory, or a pager.

Most PC Card problems occur during installation and setup of new cards. If you're having trouble getting one or more of these devices to work together, several sections in this chapter may apply.

Resource conflicts can cause problems when using PC Cards. See [“Resolving a hardware conflict” on page 209](#).

Card Information Structure

When you insert a PC Card into a slot, the computer attempts to determine the type of card and the resources it requires by reading its Card Information Structure (CIS). Sometimes the CIS contains enough information for you to use the card immediately.

Other cards must be set up before you can use them. Use the Windows® XP PC Card (PCMCIA) Wizard to set up the card. Refer to your Microsoft® documentation for more information, or refer to the documentation that came with the PC Card.

Some card manufacturers use special software called *enablers* to support their cards. Enablers result in nonstandard configurations that can cause problems when installing the PC Card.

If your system does not have built-in drivers for your PC Card and the card did not come with an operating system driver, it may not work under the operating system. Contact the manufacturer of the PC Card for information about using the card under the operating system.

PC Card checklist

- ❖ Make sure the card is inserted properly into the slot.
See “Using PC Cards” on page 171 for how to insert PC Cards.
- ❖ Make sure all cables are securely connected.
- ❖ Occasionally a defective PC Card slips through quality control. If another PCMCIA-equipped computer is available, try the card in that machine. If the card malfunctions again, it may be defective.

Resolving PC Card problems

Here are some common problems and their solutions:

The slots appear to be dead. PC Cards that used to work no longer work.

Check the PC Card status:

- 1 Click **Start**.
- 2 Click **My Computer** icon with the secondary button, then click **Properties**.

The System Properties dialog box appears.

- 3 Click the **Hardware** tab.
- 4 Click the **Device Manager** button.
- 5 Double-click the **PCMCIA adapter**.
- 6 Double-click the appropriate PC Card.

The operating system displays your PC Card’s Properties dialog box, which contains information about your PC Card configuration and status.

The computer stops working (hangs) when you insert a PC Card.

The problem may be caused by an I/O (input/output) conflict between the PCMCIA socket and another device in the

system. Use Device Manager to make sure each device has its own I/O base address. See [“Fixing a problem with Device Manager” on page 211](#) for more information.

Since all PC Cards share the same socket, each card is not required to have its own address.

Hot swapping (removing one PC Card and inserting another without turning the computer off) fails.

Follow this procedure before you remove a PC Card:

- 1** Click the **Safely Remove Hardware** icon on the taskbar.
- 2** Click **Safely remove xxxx**, where *xxxx* is the identifier for your PC Card.

The operating system displays a message that you may safely remove the card.

- 3** Remove the card from the slot.

The system does not recognize your PC Card.

Refer to the PC Card documentation.

Removing a malfunctioning card and reinstalling it can correct many problems. For more information, see [“Using PC Cards” on page 171](#).

A PC Card error occurs.

Reinsert the card to make sure it is properly connected.

If the card is attached to an external device, check that the connection is secure.

Refer to the card’s documentation, which should contain a troubleshooting section.

Printer problems

This section lists some of the most common printer problems:

The printer will not print.

Check that the printer is connected to a working power outlet, turned on and ready (on line).

Check that the printer has plenty of paper. Some printers will not start printing when there are just two or three sheets of paper left in the tray.

Make sure the printer cable is firmly attached to the computer and the printer.

Run the printer's self-test to check for any problem with the printer itself.

Make sure you installed the proper printer drivers, as shown in [“Turning off the computer” on page 67](#).

You may have connected the printer while the computer is on. Disable Stand By mode, turn off the computer, and turn off the printer. Turn the printer back on, make sure it is on line, then turn the computer back on.

Try printing another file. For example, you could create and attempt to print a short test file using Notepad. If a Notepad file prints correctly, the problem may be in your original file.

If you cannot resolve the problem, contact the printer's manufacturer.

The printer will not print what you see on the screen.

Many programs display information on the screen differently from the way they print it. See if your program has a print preview mode. This mode lets you see your work exactly as it will print. Contact the software manufacturer for more information.

Modem problems

This section lists common modem problems:

The modem will not receive or transmit properly.

Make sure the cable from the modem to the telephone line is firmly connected to the computer's modem port and the telephone line jack.

Check the port settings to make sure the hardware and software are referring to the same COM port. See [“Determining the COM port” on page 158](#).

Check the communications parameters (baud rate, parity, data length and stop bits) specified in the communications program. It should be set up to transmit at 300, 1200, 2400, 4800, 9600, 14400, 28800, 33600 bps (bits per second) or higher. Refer to the program's documentation and the modem manual for information on how to change these settings.



TECHNICAL NOTE: Disable Call Waiting before you connect through the modem. Call Waiting interrupts data transmission.

The modem is on, set up properly and still will not transmit or receive data.

Make sure the line has a dial tone. Connect a telephone handset to the line to check this.

The other system may be busy or off line. Try making a test transmission to someone else.

Develop good computing habits

Make sure you are prepared.

Save your work frequently.

You can never predict when your computer will lock, forcing you to close a program and lose unsaved changes. Many

software programs build in an automatic backup, but you should not rely solely on this feature. Save your work! See [“Computing tips” on page 71](#) for instructions.

On a regular basis, back up the information stored on your hard disk.

Here are some ways you can do this:

- ❖ Copy files to diskette, following the steps in [“Saving your work” on page 80](#).
- ❖ Connect a tape drive to the system and use specialized software to copy everything on the hard disk to a tape.

Some people use a combination of these methods, backing up all files to tape weekly and copying critical files to diskette on a daily basis.

If you have installed your own programs, you should back up these programs as well as your data files. If something goes wrong that requires you to reformat your hard disk and start again, reloading all your programs and data files from a backup source will save time.

Read the user’s guides.

It’s very difficult to provide a fail-safe set of steps you can follow every time you experience a problem with the computer. Your ability to solve problems will improve as you learn about how the computer and its software work together.

Get familiar with all the user’s guides provided with your computer, as well as the manuals that come with the programs and devices you purchase.

Your local computer store or book store sells a variety of self-help books you can use to supplement the information in the manuals.

If you need further assistance

If you have followed the recommendations in this chapter and are still having problems, you may need additional technical assistance. This section contains the steps to take to ask for help.

Before you call

Since some problems may be related to the operating system or the program you are using, it is important to investigate other sources of assistance first.

Try the following before contacting Toshiba:

- ❖ Review the troubleshooting information in your operating system documentation.
- ❖ If the problem occurs while you are running a program, consult the program's documentation for troubleshooting suggestions. Contact the software company's technical support group for their assistance.
- ❖ Consult the dealer from whom you purchased your computer and/or program. Your dealer is your best source for current information.

For the number of a Toshiba dealer near you in the United States, call: (800) 457-7777.

Contacting Toshiba

If you still need help and suspect that the problem is hardware-related, Toshiba offers a variety of resources to help you.

- 1** Start with accessing Toshiba on the Internet using any Internet browser by typing pcsupport.toshiba.com
- 2** Next, try one of Toshiba's online services. The Toshiba Forum can be accessed through CompuServe[®] by typing: [go toshiba](http://go.toshiba).

Toshiba voice contact

Before calling Toshiba, make sure you have:

- ❖ Your computer's model and model number.
- ❖ Your computer's serial number.
- ❖ The computer and any optional devices related to the problem.
- ❖ Backup copies of your operating system and all other preloaded software on diskettes or CD-ROM.
- ❖ Name and version of the program involved in the problem along with its installation diskettes or CD-ROM.
- ❖ Information about what you were doing when the problem occurred.
- ❖ Exact error messages and when they occurred.

For technical support, call the Toshiba InTouch® Center:

Within the United States at (800) 457-7777

Outside the United States at (949) 859-4273

Other Toshiba Internet Web sites

toshiba.com	Worldwide Toshiba corporate site
computers.toshiba.com	Marketing and product information in the USA
toshiba.ca	Canada
toshiba-Europe.com	Europe
toshiba.co.jp/index.htm	Japan
http://servicio.toshiba.com	Mexico and all of Latin America

Toshiba's worldwide offices

Australia

Toshiba (Australia) Pty. Limited
84-92 Talavera Road
North Ryde NSW 2113
Sydney
Australia

Belgium

Toshiba Information Systems Benelux
(Belgium) B.V.
Excelsiorlaan 40
B-1930 Zaventem
Belgium

Czech Republic

CHG Toshiba, s.r.o.
Hnevkovskeho 65
61700 Brno

Finland

Scribona TPC OY
Sinimäentie 14
P.O. Box 83
02630 ESPOO
Finland

Germany

Toshiba Europe GmbH
Leibnizstraße 2
D-93055 Regensburg
Germany

Hungary

Technotrade Kft.
Szerencs utca 202
1147 Budapest
Hungary

Austria

Toshiba Europe GmbH
Handelskai 388
1020 Wien, Austria

Canada

Toshiba Canada Ltd.
191 McNabb Street
Markham, Ontario
L3R - 8H2
Canada

Denmark

Scribona Danmark A/S
Naverland 27
DK2600 Glostrup
Denmark

France

Toshiba Systèmes (France) S.A.
7, Rue Ampère
92804 Puteaux Cédex
France

Greece

Ideal Electronics S.A.
109 Syngrou Avenue
176 71 Kalithea
Athens
Greece

Ireland

Toshiba Information Systems
(U.K) Ltd.
Toshiba Court
Weybridge Business Park
Addlestone Road
Weybridge KT15 2UL
United Kingdom

Italy

Progetto Elettronica 92 s.r.l.
Viale Certosa 138,
20156 Milano
Italy

Luxembourg

Toshiba Information Systems Benelux
B.V.
Rivium Boulevard 41
2909 LK, Capelle a/d IJssel
The Netherlands

Morocco

C.B.I.
22 Rue de Béthune
Casablanca
Morocco

Norway

Scribona Norge A/S
Toshiba PC Service
Stalfjaera 20
P.O. Box 51
Kalbakken
0901 OSLO 9
Norway

Poland

TECHMEX S.A.
ul. Partyzantów 71,
43-316 Bielsko-Biala
01-059 Warszawa
Poland

Singapore

Toshiba Singapore Pte. Ltd.
438B Alexandra Rd. # 06-01
Alexandra Technopark
Singapore 119968

Japan

Toshiba Corporation, PCO-IO
1-1, Shibaura 1-Chome
Minato-Ku, Tokyo, 105-8001
Japan

Mexico and all of Latin America

Toshiba de México S.A. de C.V.
Sierra Candela No.111, 6to. Piso
Col. Lomas de Chapultepec.
CP 11000 Mexico, DF.
800-457-7777 (outside of the US)
949-859-4273 (within the US - this call
may incur long distance charges)

The Netherlands

Toshiba Information Systems Benelux
B.V.
Rivium Boulevard 41
2909 LK, Capelle a/d IJssel
The Netherlands

Papua New Guinea

Fujitsu (PNG) Pty. Ltd.
P.O. Box 4952 Boroko
NCD, Papua
New Guinea

Portugal

Quinta Grande Assistência Técnica
Informática, Lda.
Av. Moinhos no. 15A
Ur. Quinta Grande
2720 Alfragide
Portugal

Slovakia

HTC a.s.
Dobrovicova 8
81109 Bratislava
Slovakia

Slovenia

Inea d.o.o.
Ljubljanska 80
61230 Domzale
Slovenia

Sweden

Scribona PC AB
Sundbybergsvägen 1
Box 1374
171 27 Solna
Sweden

United Kingdom

Toshiba Information Systems
(U.K) Ltd.
Toshiba Court
Weybridge Business Park
Addlestone Road
Weybridge KT15 2UL
United Kingdom

The Rest of Europe

Toshiba Europe (I.E.) GmbH
Hammfelddamm 8
D-4-1460 Neuss
Germany

Spain

Toshiba Information Systems (España)
S.A.
Parque Empresarial San Fernando
Edificio Europa, 1a Planta
Escalera A
28831 (Madrid) San Fernando de
Henares
Spain

Switzerland

Ozalid AG
Herostrasse 7
8048 Zürich
Switzerland

United States

Toshiba America Information
Systems, Inc.
9740 Irvine Boulevard
Irvine, California 92618
United States

Appendix A

Hot Keys

Hot keys are keys that, when pressed in combination with the Fn key, turn system functions on and off. Hot keys have a legend on or above the key indicating the option or feature the key controls.



All functionality is the same when the keyboard is in wireless mode.

Volume Mute

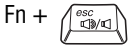

This hot key enables/disables volume mute on your computer.



When volume mute is enabled, no sound will come from the speakers or headphones.



Instant password security

Fn +



This hot key causes the screen to become blank, hiding whatever was previously displayed.

Without a password

The Fn + F1 key combination turns off the display and activates instant security. Using the mouse or any key will make the display reappear.

With a password

The Fn + F1 key combination turns off the display and activates instant security. Using the mouse or any key will make the screen saver password dialog box appear, and you can then type in either a user or supervisor password.

For the Windows[®] XP operating system, you type the user or supervisor password into the Windows[®] security screen dialog box.

To activate the password feature:

- 1 Click **Start, Control Panel**.
- 2 Click **Appearances and Themes**
- 3 Click one of the following:
 - ❖ **Choose a screen saver** in the **Pick a task** section
 - ❖ **Display** in the **or pick a Control Panel icon** section

The Display Properties window appears.

- 4 If you clicked **Choose a screen saver**, the Screen Saver tab has already been selected. If it isn't selected, click the **Screen Saver** tab.
- 5 Click the **On resume, password protected** check box.
- 6 Click **OK**.

Power usage mode

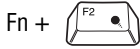

This hot key displays the power usage pop-up window and cycles through the battery save modes.

The power usage modes in the operating system under battery power are:

Long Life, Normal, and High Power; User Defined

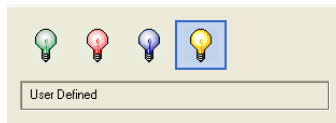

Sample power usage modes

The power usage modes in the Windows[®] operating system under AC power are Full Power and User Defined.

The properties of each mode are set in the Toshiba Power Management utility. For more information, see “[Power Management](#)” on page 176.

Stand By mode



This hot key puts the computer into Stand By mode.

- ❖ A message box is displayed by default to confirm that the computer is going into Stand By mode. This message box can be set so it doesn't display.

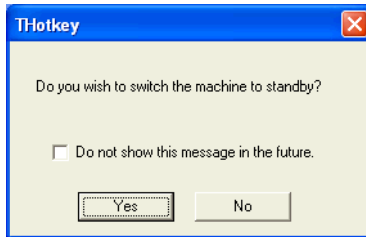

Sample Stand By confirmation box

- ❖ For more information about Stand By mode, please see [“Using Standby” on page 104](#).

Hibernation mode



This hot key puts the computer into Hibernation mode.

- ❖ If Hibernation mode is enabled (the default) a message box is displayed by default to confirm the computer is going into Hibernation mode. The message box can be set so it doesn't display.

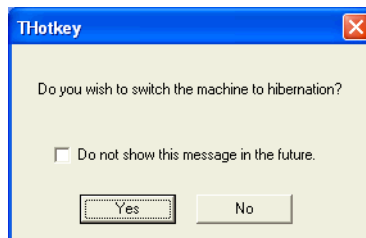

Sample Hibernation confirmation box

- ❖ If Hibernation mode is disabled, this hot key will not respond. For more information on Hibernation mode, see [“Using Hibernation” on page 102](#).

Display modes



This hot key cycles through the power-on display options.

The display modes options are:

- ❖ Built-in display panel only
- ❖ Built-in display panel and external monitor simultaneously
- ❖ External monitor only
- ❖ TV+LCD
- ❖ TV only

In order to use a simultaneous mode, you must set the resolution of the built-in display panel to match the resolution of the external display device. Simultaneous mode works only with external monitors that support 640 X 480 resolution and higher.

Display brightness

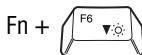

This hot key decreases the screen brightness.

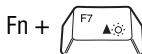

This hot key increases the screen brightness.



Enabling a wireless device

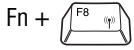

This hot key enables/disables the optional wireless devices in your computer.

The wireless mode is:

- ❖ Wi-Fi enabled—This enables the Wi-Fi antenna.

Disabling or enabling the TouchPad

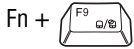

This hot key enables/disables the TouchPad.

To use the TouchPad, see [“Using the TouchPad™” on page 53](#).



Sample disable and enable TouchPad windows

Keyboard hot keys



This hot key turns the cursor control overlay on and off.

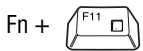

This hot key turns the numeric overlay on and off.

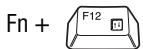

This hot key turns the scroll lock feature on and off.

Appendix B

Power Cable Connectors

Your notebook computer features a universal power supply you can use worldwide. This appendix shows the shapes of the typical AC power cable connectors for various parts of the world.

USA and Canada



UL approved
CSA approved

United Kingdom

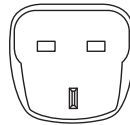

BS approved

Australia



AS approved

Europe



VDA approved
NEMKO approved

— Blank Page —

Glossary



TECHNICAL NOTE: Some features defined in this glossary may not be available on your computer.

Acronyms

The following acronyms may appear in this user's guide.

AC	alternating current
BIOS	basic input/output system
bps	bits per second
CD	compact disc
CD-ROM	compact disc read-only memory
CD-RW	compact disc rewrite memory
CMOS	complementary metal-oxide semiconductor
COM1	communications port 1 (serial port)
COM2	communications port 2 (serial port)
CPU	central processing unit
DC	direct current

DMA	direct memory access
DIMM	dual inline memory module
DOS	disk operating system
DPI	dots per inch
DSTN	dual supertwist nematic
DVD	digital versatile (or video) disc
DVD-ROM	digital versatile (or video) disc read-only memory
ECP	enhanced capabilities port
EPROM	erasable programmable read-only memory
FAT	file allocation table
FCC	Federal Communications Commission
FIR	fast infrared
GB	gigabyte
HDD	hard disk drive
HTML	Hypertext Markup Language
IEEE	Institute of Electrical and Electronics Engineers
I/O	input/output
IRQ	interrupt request
ISP	Internet service provider
KB	kilobyte
LAN	local area network
LCD	liquid crystal display
LPT1	line printer port 1 (parallel port)
LSI	large-scale integration
MB	megabyte
MIDI	Musical Instrument Digital Interface
PC	personal computer
PCI	Peripheral Component Interconnect
PCMCIA	Personal Computer Memory Card International Association

RAM	random access memory
RFI	radio frequency interference
ROM	read-only memory
RTC	real-time clock
SCSI	small computer system interface
SDRAM	synchronous dynamic random access memory
SRAM	static random access memory
SVGA	super video graphics adapter
TFT	thin film transistor
USB	universal serial bus
URL	uniform resource locator
WAN	wide area network
www	World Wide Web

Terms

The following terms may appear in this user's guide.

A

active-matrix display — A liquid crystal display (LCD) made from an array of liquid crystal cells using active-matrix technology. Also known as a “TFT display,” in its simplest form there is one thin film transistor (TFT) for each cell. This type of display works well with notebook computers because of its shallow depth and high-quality color. Active-matrix displays are viewable from wider angles than most passive-matrix displays.

adapter — A device that provides a compatible connection between two units. For example, the computer's internal display adapter receives information from the software and translates it into images on the screen. An adapter can take a number of forms, from a microprocessor to a simple connector. An intelligent adapter (one that is capable of doing some processing) may also be called a controller.

alternating current (AC) — The type of power usually supplied to residential and commercial wall outlets. AC reverses its direction at regular intervals. Compare *direct current (DC)*.

application — A computer program that you use to perform tasks of a specific type. Applications include word processors, spreadsheets, and database management systems. See also *program*.

B

backup — A copy of a file, usually on a removable disk, kept in case the original file is lost or damaged.

basic input/output system (BIOS) — See *BIOS*.

baud rate — The speed at which a communication device, such as a printer or modem, transmits information. Baud rate is the number of signal changes per second (not necessarily the same as bits per second). See also *bits per second*.

BIOS (basic input/output system) — Basic instructions, stored in read-only memory (ROM), containing the information the computer needs in order to check hardware and load the operating system when you start up the computer.

bit: — Short for “binary digit.” A bit is the smallest unit of information used by a computer. A group of eight bits is a byte. See also *byte*.

bits per second (bps) — A way of measuring the speed at which information is passed between two devices. The basic measure used in modem communications, bps is similar, but not identical, to the baud rate. See also *baud rate*.

boot — To start the computer. The term “boot” originates from bootstrap program (as in “pulling itself up by its bootstraps”), a program that loads and initializes the operating system. See also *reboot*.

boot disk — See *system disk*.

boot priority (startup sequence) — The order in which the computer accesses its disk drives to locate the startup files. Under the default startup sequence, the computer looks for the startup files in the diskette drive before checking the hard disk.

bus — An electrical circuit that connects the central processing unit (CPU) with other parts of the computer, such as the video adapter, disk drives, and ports. It is the pathway through which data flows from one device to another. See also *bus speed*, *frontside bus*.

bus speed — The speed at which the central processing unit (CPU) communicates with the other parts of the computer.

byte — A sequence of eight bits. A byte is the smallest addressable unit of data. See also *bit*, *gigabyte*, *kilobyte*, *megabyte*.

C

cache — A section of very fast memory in which frequently used information is duplicated for quick access. Accessing data from cache is faster than accessing it from the computer's main memory. See also *CPU cache*, *L1 cache*, *L2 cache*.

CD — An individual compact disc. See also *CD-ROM*.

CD-ROM (compact disc read-only memory) — A form of high-capacity storage that uses laser optics instead of magnetic means for reading data. See also *CD*. Compare *DVD-ROM*.

central processing unit (CPU) — The chip that functions as the “brain” of the computer. It takes information from outside sources, such as memory or keyboard input, processes the information, and sends the results to another device that uses the information.

character — Any letter, number, or symbol you can use on the computer. Some characters are non-printing characters, such as a paragraph break in a word-processing program. A character occupies one byte of computer storage.

chip — A small piece of silicon containing computer logic and circuits for processing, memory, input/output, and/or control functions. Chips are mounted on printed circuit boards.

click — To press and release the control button or mouse button without moving the cursor with the TouchPad or mouse. In the operating system, this refers to the left mouse button or primary control button, unless otherwise stated. See also *double-click*.

color palette — A set of specified colors that establishes the colors that can be displayed on the screen at a particular time.

compatibility — The extent to which computers, programs, or devices can work together harmoniously, using the same commands, formats, or language as another.

configuration — (1) The collection of components that make up a single computer system. (2) How parts of the system are set up (that is, configured).

controller — A device that controls the transfer of data from a computer to a peripheral device and vice versa. For example, disk drives, monitors, keyboards, and printers all require controllers.

CPU — See *central processing unit (CPU)*.

CPU cache — A section of very fast memory residing between the CPU and the computer's main memory that temporarily stores data and instructions the CPU will need to execute commands and programs. See also *cache, L1 cache, L2 cache*.

cursor — A symbol that indicates the current position on the screen. The shape of the cursor varies, depending on the program you're using and what you're doing.

D

default — The setting selected by a program when the user does not specify an alternative setting.

device — A component attached to the computer. Devices may be external (outside the computer's case) or internal (inside the computer's case). Printers, disk drives, and modems are examples of devices.

device driver — A program (called a "driver") that permits a computer to communicate with a device.

dialog box — An on-screen window displayed by the operating system or a program giving a direction or requesting input from the user.

direct current (DC) — The type of power usually supplied by batteries. DC flows in one direction. Compare *alternating current (AC)*.

direct memory access (DMA) — A dedicated channel, bypassing the CPU, that enables direct data transfer between memory and a device.

directory — See *folder*.

disable — To turn a computer option off. See also *enable*.

disc — A round, flat piece of metal, designed to be read from and written to by optical (laser) technology, and used in the production of optical discs, such as CDs and DVDs. Compare *disk*.

disk — A round, flat piece of material that can be magnetically influenced to hold information in digital form, and used in the production of magnetic disks, such as diskettes and hard disks. Compare *disc*. See also *diskette*, *hard disk*.

disk drive — The device that reads and writes information and programs on a diskette or hard disk. It rotates the disk at high speed past one or more read/write heads.

diskette — A thin, flexible disk in a protective jacket that stores magnetically encoded data. Diskettes can be removed from the computer. Your computer uses 3.5-inch diskettes.

document — Any file created with an application and, if saved to disk, given a name by which it can be retrieved. See also *file*.

double-click — To press the control button or mouse button rapidly twice without moving the cursor with the mouse. In the operating system, this refers to the primary control button or left mouse button, unless otherwise stated.

download — (1) In communications, to receive a file from another computer through a modem or network. (2) To send font data from the computer to a printer. See also *upload*.

drag — To hold down the control button or mouse button while moving the cursor to drag a selected object. In the operating system, this refers to the primary control button or left mouse button, unless otherwise stated.

driver — See *device driver*.

DVD — An individual digital versatile (or video) disc. See also *DVD-ROM*.

DVD-ROM (digital versatile [or video] disc read-only memory) — A very high-capacity storage medium that uses laser optics for reading data. Each DVD-ROM can hold as much data as several CD-ROMs. Compare *CD-ROM*.

E **emulation** — A technique in which a device or program imitates another device or program.

enable — To turn on a computer option. See also *disable*.

executable file — A computer program that is ready to run. Application programs and batch files are examples of executable files. Names of executable files usually end with a *.bat* or *.exe* extension.

expansion device — A device that connects to a computer to expand its capabilities. Other names for an expansion device are port expander, port replicator, docking station, or network adapter.

extension — See *file extension*.

external device — See *device*.

F **file** — A collection of related information, saved on disk with a unique name. A file may be a program, information used by a program, or a document. See also *document*.

file allocation table (FAT) — The section of a disk that keeps track of the location of files stored on the disk.

file name — A set of characters that uniquely identifies a file within a particular folder. It consists of two parts: the actual name and the file name extension. See also *file extension*.

file extension — The three characters following the period (pronounced “dot”) at the end of a file name. The extension indicates the type of file. Examples are *.exe* for program files and *.hlp* for help files. See also *file name*.

folder — Also called directory. A container for organizing files saved to a disk. A folder is symbolized on screen by a graphical image (icon) of a file folder. A folder can contain files and other folders.

format — (verb) To prepare a blank disk for use with the computer's operating system. Formatting creates a structure on the disk so the operating system can write information to the disk or read information from it.

frontside bus — The primary pathway (bus) between the CPU and the computer's main memory. Also called "system bus." See also *bus*.

function keys — The keys labeled F1 through F12, typically located on the keyboard. Their function is determined by the operating system and/or individual programs.

G

gigabyte (GB) — A unit of data equal to 1,073,741,824 bytes (1024 x 1024 x 1024 bytes). See also *byte*.

ground — A conductor to which all components of an electric circuit are connected. It has a potential of zero (0) volts, is connected to the earth, and is the point of reference for voltages in the circuit.

H

hard disk — A storage device composed of a rigid platter or platters that can be magnetically coded with data. Hard disks hold much more information than diskettes and are used for long-term storage of programs and data. The primary (or only) hard disk in a computer is usually fixed, but some computers have secondary hard disks that are removable. By default, the hard disk is referred to as drive C.

hardware — The physical components of a computer system. Compare *software*.

Hibernation — A feature of many Toshiba notebook computers that saves to the hard disk the current state of your work, including all open files and programs, when you turn the computer off. When you turn on the computer again, your work is returned to the same state it was when the computer was turned off. See also *Stand By*, *Suspend*.

high-density diskette — A 3.5-inch diskette that holds 1.44 MB of data. See also *diskette*.

hot key — (1) A feature in which certain keys in combination with the Fn key can set system options or control system parameters, such as the battery save mode. (2) A key or combination of keys that activates a memory resident program.

hot swapping — The ability to add or remove devices from a computer while the computer is running and have the operating system automatically recognize the change.

I icon — A small image displayed on the screen that represents a function, file, or program.

interlaced — A method of refreshing a computer screen, in which only every other line of pixels is refreshed. Interlaced monitors take two passes to create a complete screen image. Compare *non-interlaced*.

internal device — See *device*.

Internet — The decentralized, world-wide network of computers that provides electronic mail, the World Wide Web, and other services. See also *World Wide Web*.

K keyboard shortcut — A key or combination of keys that you use to perform a task instead of using the mouse and control buttons combination.

kilobyte (KB) — A unit of data equal to 1024 bytes. See also *byte*.

L L1 (level one) cache — Memory cache built into the processor to help improve processing speed. See also *cache*, *CPU cache*, *L2 cache*.

L2 (level two) cache — Memory cache installed on the motherboard to help improve processing speed. It is slower than L1 cache and faster than main memory. See also *cache*, *CPU cache*, *L1 cache*.

LAN (local area network) — A group of computers or other devices dispersed over a relatively limited area and connected by a communications link that enables any device to interact with any other on the network.

liquid crystal display (LCD) — A type of display that uses a liquid substance between two transparent electrode panels. When an electric current passes through the electrodes, the molecules in the liquid form a crystalline pattern that polarizes the light passing through it. A filter over the electrodes permits only non-polarized light to pass to the surface of the display, creating light and dark pixels.

load — To move information from a storage device (such as a hard disk) into memory for processing.

local area network — See *LAN*.

logical drive — A section of a disk that is recognized by the operating system as a separate disk drive. A system's logical drives may differ from its physical drives. For example, a single hard disk drive may be partitioned into two or more logical drives.

M

megabyte (MB) — A unit of data equal to 1,048,576 bytes (1024 x 1024 bytes). See also *bytes*.

memory — Typically refers to the computer's main memory, where programs are run and data is temporarily stored and processed. Memory can be volatile and hold data temporarily, such as RAM, or it can be nonvolatile and hold data permanently, such as ROM. A computer's main memory is RAM. See *RAM*, *ROM*.

microprocessor — See *central processing unit (CPU)*.

MIDI (Musical Instrument Digital Interface) — A standard for connecting musical instruments, synthesizers, and computers. The MIDI standard provides a way of translating music into a form computers can use, and vice versa.

modem — Short for "modulator/demodulator." A device that converts information from digital to analog and back to digital, enabling information to pass back and forth between digital computers and analog telephone lines.

motherboard — The main circuit board in the computer. It contains the processor, memory, and other primary components.

MS-DOS prompt — See *system prompt*.

multimedia — A combination of two or more media, such as sound, animation, and video in a computer program or presentation.

Musical Instrument Digital Interface — See MIDI.

N

network — A collection of computers and associated devices that are connected by communications facilities. A network allows you to share data and peripheral devices, such as printers, with other users and to exchange electronic mail.

non-interlaced — A method of refreshing a computer screen, in which each pixel of every line is refreshed as the electron beam scans across and down the screen. Compare *interlaced*.

non-system disk — A disk for storing programs and data that cannot be used to start the computer. Compare *system disk*.

O

online — Available through the computer. Online may refer to information being read from your own computer's hard disk, such as online documentation or online help, or to information coming from another company on a company network or the Internet.

operating system — A set of programs that controls how the computer works. Examples of operating systems are Windows® XP and Windows® Millennium Edition operating systems.

P

palette — See *color palette*.

parallel — Processes that occur simultaneously. In communications, it means the transmission of more than one bit of information at a time. On your computer, the parallel port provides a parallel communications interface between the computer and an appropriate device. Most modern printers are parallel. Compare *serial*.

password — A unique string of characters entered by a user to verify his or her identity to the computer or the network.

PC Card — A credit-card-sized expansion card designed to increase the capabilities of notebook computers. PC Cards provide functions such as modem, fax/modem, hard disk drive, network adapter, sound card, or SCSI adapter.

peripheral — Any device, such as a printer or joystick, that is attached to the computer and controlled by the computer's CPU.

pixel — Short for "picture element." The smallest dot that can be produced on a screen or printer.

Plug and Play — Generally, refers to the computer's ability to automatically configure itself to work with peripheral devices. When capitalized, refers to a standard that, when followed by a device manufacturer, allows a PC to configure itself automatically to work with the device.

pointing device — Any device, such as the mouse, that enables you to move the cursor on the screen.

port — A socket on the computer where you plug in a cable for connection to a network or a peripheral device.

processor — See *central processing unit (CPU)*.

program — A set of instructions that can be executed by a computer. The general classes of programs (also called software) are operating system, application, and utility. See also *operating system, application, utility*.

properties — The attributes of an object or device. For example, the properties of a file include the file's type, size, and creation date.

R

RAM (random access memory) — Volatile memory that can be written to as well as read. By volatile, we mean that information in RAM is lost when you turn off your computer. This type of memory is used for your computer's main memory. See also *memory*. Compare *ROM*.

random access memory — See *RAM*.

read-only memory — See *ROM*.

reboot — See *boot, restart*.

removable disk — A disk that can be removed from a disk drive. A diskette is one example of a removable disk.

resolution — A measure of the sharpness of the images that can be produced by a printer or displayed on a screen. For a printer, resolution is expressed in dots per inch (dpi). For a screen, it is expressed as the number of pixels available horizontally and vertically.

restart — Synonymous with reboot. To reset the computer by reloading the operating system without turning the computer off. See also *boot*.

RJ11 — A modular connector used on most U.S. telephone systems and direct-connect modems. The RJ11 connector is a 4-wire connector.

ROM (read-only memory) — Non-volatile memory that can be read but not written to. By non-volatile, we mean that information in ROM remains whether or not the computer is receiving power. This type of memory is used to store your computer's BIOS, which is essential instructions the computer reads when you start it up. See also *BIOS*, *memory*. Compare *RAM*.

S

select — To highlight or otherwise specify text, data, or graphics with the intent to perform some operation on it.

serial — Processes that occur one at a time. In communications, it means the transmission of one bit at a time sequentially over a single channel. On your computer, the serial port provides a serial interface between the computer and an appropriate device. Compare *parallel*.

shortcut — See *keyboard shortcut*.

software — See *program*. Compare *hardware*.

Standby — A feature of some operating systems that allows you to turn off the computer without exiting your open applications and to continue from where you left off when you turn the computer on again.

system disk — A diskette that contains the operating system files needed to start the computer. Any diskette can be formatted as a system disk. A system disk is also called a “bootable disk” or a “startup disk.” Compare *non-system disk*.

system prompt — The symbol (in the MS-DOS® operating system, generally a drive letter followed by a “greater than” sign) indicating where users are to enter commands.

**T
U**

TFT display — See *active-matrix display*.

universal serial bus (USB) — A serial bus that supports a data transfer rate of up to 12 Mbps (12 million bits per second). USB can connect up to 127 peripheral devices through a single all-purpose USB port. USB allows hot swapping of peripherals. See also *bus, hot swapping, serial*.

upload — To send a file to another computer through a modem or network. See also *download*.

USB — See *universal serial bus (USB)*.

utility — A computer program designed to perform a narrowly focused operation or solve a specific problem. Utilities are often related to computer system management.

W

Web — See *World Wide Web*.

Wi-Fi — A trademarked term by the Wireless Compatibility Ethernet Alliance which stands for Wireless Fidelity. Wi-Fi is another term for the IEEE 802.11b communication protocol to permit an Ethernet connection using wireless communication components.

World Wide Web (www) — The worldwide network of Web sites linked together over the Internet. A user of the Web can jump from site to site regardless of the location of the computer hosting the site. See also *Internet*.

Index

A

- AC adapter 48
- AC power light 35, 48, 52
- Accessories programs 146
- adding
 - memory 57
- alarms
 - low battery 113
- audio CDs
 - playing 85
- audio features 167
- avoiding injury 40

B

- battery
 - alarms 113
 - changing 114
 - charge not lasting 214
 - charging 50, 67, 109
 - conserving power 112
 - disposal 119
 - inserting 116
 - installing 114
 - light 35, 52, 111

- Li-Ion (Lithium Ion) 107
 - monitoring power 111
- NiMH (nickel metal hydride)
 - 108
 - not charging 214
 - power usage mode 243
 - recharging 109
 - remaining power 111
 - removing 114
 - RTC (real-time clock) 108, 110
 - safety precautions 108
 - setting alarms 113

- battery cover 38
 - latch 38

- buttons
 - CD Player 91, 92
 - CD/DVD controls 33, 36, 85
 - DVD-ROM drive
 - eject 86
 - next track 37
 - play/pause 37
 - power 32
 - previous track 36, 37
 - Start 123

stop 37

C

calculator 138

CD Player control panel 91, 92

CD/DVD control buttons 33, 36, 85

CD/DVDs

 caring for 93

 inserting 89, 90

 playing 85

 viewing contents 93

CD-ROM, DVD-ROM, DVD-ROM/

 CD-RW safety instructions 10

CD-ROMs

 using 85

 writing 30

CDs 33, 93

 inserting 90

 problem solving 220

changing

 main battery 114

channels

 DMA 210

 IRQ 210

Character Map 139

charging

 main battery 50, 67, 109

 RTC (real-time clock) battery

 110

checking device properties 212

cleaning

 CD/DVDs 93

 computer 68

 diskettes 83

click 53

closing programs 137

COM port 158

comfort

 chair 41

 lighting 42

 work habits 43

commands

 Hibernation 98

 Stand By 99

 Turn Off 97

communications

 network connection 160

 programs 94

 setting up 94

 system resources 210

 via modem 95

compact discs

 inserting 90

 problem solving 220

 removing 91

computer

 cleaning 68

 lock 69

 moving 68

 non-system disk or disk error

 message 206

 not accessing disk drives 206

 placement 40

 protection 39

 running on battery power 107

 setting up 45, 57

 turning off 100, 150

 turning on 51

 using at the office 158

 warning resume failure message

 206

 work area 39

computing tips 71

connecting

 AC adapter 48

 external monitor 158

 external speakers 170

 headphones 170

 modem 95

 monitor 65

- power cable 49
- television 65
- to a network 95
- USB-compatible
 - keyboard 61
- video projector 65

conserving battery power 112

cursor control mode light 34

customizing

- taskbar 152
- window toolbars 155

D

Date 143

date and time

- setting 143

DC-IN jack 48

desktop 122

- background 124
- browsing style 153
- choosing style and browsing
 - options 153
- creating new icon 123
- creating shortcuts 138
- major features 122
- properties 141
- shortcut menu 126
- Start button 123
- system tray 124
- taskbar 124, 135

Device Manager 211

- checking properties 212
- disabling a device 211, 212

devices

- keyboard 61

Digital Subscriber Lines (DSL) 163

Digital Versatile Discs 85

DirectX Foundation 224

disk activity light 36

Disk Defragmenter 218

disk drive

- corrupted/damaged data files 218
- missing files/trouble accessing a disk 217
- running slow 218

diskette drive 82

- can't insert a diskette 219
- can't read a diskette 219

diskettes

- caring for 82
- cleaning 83
- copying files to 83
- inserting and removing 82

display 33

- doesn't look normal/flickers 216
- external monitor not working 217
- external, adjusting 66
- hot key 65
- latch 51
- LCD 33
- properties 142
- screen is blank 215
- television, connecting 65
- video projector, connecting 65

display limitations 66

display panel

- opening 51

displaying folder information 156

disposing of used batteries 119

DMA (Direct Memory Access) 210

double-click 54

downloading 165

DVD player

- playing DVDs 179

DVD-ROM 36, 94

- launch WinDVD 167

DVD-ROM drive 30, 85, 167

- inserting a disc 89
- problems 219
- troubleshooting 212

- DVD-ROM/CD-RW
 - launch WinDVD 167
- DVD-ROM/CD-RW drive 30, 85, 94, 167
 - can't access disc 219
 - drive tray won't open 220
 - eject button 86
 - light 36
 - manual eject hole/button 86
 - problems 219
 - troubleshooting 212
- DVDs 33, 85
 - playing 167
- E**
- email 164
- emulating a full-size keyboard 76
- energy saving features 107
- environmental considerations 40, 41
- ergonomics
 - lighting 42
 - posture 41
 - seating guidelines 41
 - work habits 43
- error messages
 - device driver conflict 209
 - general hardware problem 209
 - non-system disk or disk error 206, 219
 - problem with display settings/
 - current settings not working
 - with hardware 217
 - program has performed an illegal operation 204
 - warning resume failure 206
 - WinDVD 224
- Error-checking 218
- Ethernet 10/100 Ethernet LAN adapter 95
- expansion memory slot 58

- cover 38
- external
 - keyboard 61
- external microphone
 - connecting 168
- external monitor
 - connecting 158
 - not working 217
- external speakers 170

F

- FAT (File Allocation Table) 217
- files 124
 - backing up 72, 83
 - copying to diskette 83
 - printing 81
 - saving 71, 80
- Fn key 32
- folders 124
 - displaying information 156
- front panel 33
- function keys 32, 73

H

- hard disk drive
 - cover 38
 - light 35, 52
- hardware conflicts 209
 - resolving 210
- headphone jack 170
- headphones
 - connecting 170
 - jack 30
- Help 147
 - Windows XP 208
- Hibernation 98
 - factors to consider 98
 - low battery 113
 - restarting 98
- Hibernation mode 67, 102

- configuring 103
- starting again from 103
- hiding windows 134
- hot key
 - display modes 245
 - display output settings 65
 - keyboard 246
 - keyboard overlays 246
 - power usage mode 243
 - Standby mode 244
 - volume mute 241
 - wireless mode 246
- hot keys 241
- hot swapping
 - precautions 174
- Hypertext Transfer Protocol (HTTP) 162

I

- icon 123
 - desktop 123
 - internet explorer 123
 - moving to desktop 123
 - naming 131
 - safety 24
- indicator panel
 - keyboard 33
 - system 33, 35
- inserting
 - CDs and DVDs 90
 - main battery 116
 - PC Cards 172
- installing
 - main battery 114
 - memory module 57
- installing batteries in mouse 55
- Internal/External mode 217
- Internet 162
 - bookmarked site not found 208
 - chat rooms 164

- connecting to 163
- news groups 164
- overview 162
- slow connection 208
- URL address not found 208

- internet explorer icon 123
- Internet Service Provider (ISP) 163
- IRQ (Interrupt Request) 210

J

- jacks
 - external speakers 30
 - headphone 30
 - microphone 30
 - video/audio out 29

K

- keyboard 33
 - character keys 73
 - Ctrl, Fn, and Alt keys 73
 - cursor control overlay 75
 - emulating full-size 76
 - external 61
 - function keys 73
 - hot keys 246
 - indicator panel 33, 34
 - lights 33
 - not working 205, 215
 - numeric keypad overlay 75
 - overlay keys 74
 - unexpected characters 215
 - using 76
 - Windows special keys 74

L

- LAN (Local Area Network)
 - adapter 95
- lights
 - AC power 35, 48, 52
 - battery 35, 52, 111
 - cursor control mode 34

- disk activity 36
- diskette activity 82
- diskette drive 36
- DVD-ROM/CD-RW drive 36
- hard disk drive 35, 52
- keyboard 33
- numeric mode 34
- on/off 35
- system 33

lock slot 29

M

- main battery
 - changing 114
 - recharging 109
 - removing 114
- memory
 - adding 57
 - problem solving 213
 - removing 60
 - removing expansion slot cover 58
- memory module
 - inserting 59
- microphone jack 30
- Microsoft Internet Explorer 94
- Microsoft Support Online Web site 209
- Microsoft Windows XP 23, 121
- minimizing 135
- modem
 - determining COM port 158
 - port 29, 95
 - problem solving 233
 - resetting port to default settings 158
 - upgrading 158
- modem, using 95
- monitor
 - connecting 65, 158
 - not working 216

- mouse
 - installing batteries 55
 - Reset button 56
 - using 55
- moving the computer 68
- My Computer 125, 126

N

- network
 - accessing 160
 - connecting to 95
 - New Connection Wizard 160
- Network Setup Wizard 96
- New Folder icon 131
- new text document 129
- next track button 37
- Notepad 130
- numeric mode light 34

O

- object properties 141
- on/off light 35
- online tours 149
- operating system 23

P

- Paint program 132
- parallel port 29
- PC Card
 - checklist 230
 - CIS (Card Information Structure) 229
 - computer stops working 230
 - eject button 32
 - errors 231
 - hot swapping fails 231
 - inserting 172
 - modem default 158
 - not recognized 231
 - problem solving 229, 230
 - removing 173

- replacing 174
 - slots 31
 - using 171
- PCMCIA (Personal Computer Memory Card International Association) 171
- play/pause button 37
- playing
- CDs and DVDs 85
- ports
- COM 158
 - LAN 29
 - modem 29
 - parallel 29
 - RGB (monitor) 29
 - USB 29, 30
- power
- cable 49
 - cable connectors 247
 - computer will not start 205
 - light 35
 - monitoring 111
 - on/off button 32
 - problem solving 213
- power down options
- Turn Off 100
- Power Management 176
- power off
- guidelines 67
- power usage mode 112
- powering down
- using Standby 104
- precautions 43
- presentations
- viewing on television set 165
- previous track button 36, 37
- primary control button 54
- printer
- Add Printer Wizard 62
 - problem solving 232
- printing a file 81
- problem solving
- AC power 213
 - accessing disk drives 206
 - battery charge doesn't last 214
 - battery not charging 214
 - can't access CD/DVD 219
 - can't insert diskette in drive 219
 - can't read a diskette 219
 - changing display properties 217
 - checking device properties 212
 - compact discs not running
 - correctly 220
 - computer hangs when PC Card inserted 230
 - computer will not power up 205
 - contacting Toshiba 235
 - corrupted/damaged data files 218
 - Device Manager 211
 - disabling a device 211, 212
 - disk drive is slow 218
 - display is blank 215
 - DVD-ROM
 - controls are gray 220
 - not functioning properly 224
 - video content poor 223
 - DVD-ROM performance is poor 221
 - DVD-ROM Root or Title menu
 - does not open 221
 - DVD-ROM slow playback 221
 - DVD-ROM/CD-RW
 - performance is poor 221
 - DVD-ROM/CD-RW drive tray
 - doesn't eject 220
 - external display not working 217
 - external keyboard not working 215
 - external monitor 216
 - faulty memory 213

- hardware conflict 209, 210
- high-pitched noise 228
- illegal operation 204
- Internet bookmarked site not found 208
- Internet connection is slow 208
- keyboard
 - not responding 205
- keyboard produces unexpected characters 215
- missing files/trouble accessing a disk 217
- modem not receiving or transmitting 233
- no sound 228
- non-system disk or disk error 206, 219
- PC Card 229
 - checklist 230
 - error occurs 231
 - hot swapping fails 231
 - not recognized 231
 - slots appear dead 230
- power and batteries 213
- printer 232
- program not responding 203
- program not working properly 218
- screen does not look right/flickers 216
- system resources 210
- trouble prevention 233
- URL address not found 208
- using Startup options 207
- warning resume failure 206
- Windows won't start 206
- Windows XP not working 206
- WinDVD error messages 224

programs

- closing 137
- not running correctly 218

- starting 79
- Web browsers 162

properties 141

R

- recharging
 - main battery 109
 - RTC battery 110
- recording
 - adjusting quality 169
 - sounds 167, 168
- Recycle Bin 123, 144
- region code 189
- remaining battery power 111
- removing
 - CDs and DVDs 91
 - main battery 114
 - PC Cards 173
- Reset button
 - using 56
- resizing windows 134, 136
- restarting the computer 102
- RGB (monitor)
 - port 29
- RTC (real-time clock) battery 108
- running the computer on battery power 107

S

- safety
 - battery 108
 - disposing of batteries 119
 - icon 24
 - precautions 43
 - traveling 120
- safety instruction
 - CD-ROM 10
 - DVD-ROM 10
- safety instructions
 - DVD-ROM/CD-RW 10

- saving your work 80
 - screen 33
 - blank 215
 - doesn't look normal/flickers 216
 - Screen Saver tab 142
 - SCSI (Small Computer Systems Interface) 174
 - Search Engine 164
 - secondary control button 54
 - security
 - fitting a computer lock cable 69
 - lock slot 29
 - SelectServ 26
 - setting
 - battery alarms 113
 - setting up
 - AC adapter 48
 - communications 94
 - computer 39, 45, 57
 - date and time 143
 - printer 62
 - shortcut
 - creating 138
 - menu 126
 - sound
 - .wav files 168
 - problem solving 228
 - speakers
 - external 170
 - jack 30
 - stereo 32
 - Stand By
 - command 67
 - factors to consider 99
 - low battery 113
 - mode 35
 - restarting 99
 - Standby 104
 - Standby mode
 - hot key 244
 - starting again from 106
 - Start button 123
 - starting a program 79
 - starting up the computer
 - from Standby 106
 - Startup menu
 - problem solving 207
 - stop button 37
 - support for Windows 124
 - system indicator panel 33, 35
 - system requirements
 - WinDVD 224
 - System Restore 146
 - System Setup 206
 - System Tools 146
 - system tray 124
- T**
- taskbar 124, 135
 - customizing 152
 - telephone line
 - connecting the modem 95
 - television
 - adjusting display 66
 - connecting 65
 - text file 129
 - time saving
 - quick Shut down 100
 - tips on computing 71
 - toolbars
 - customizing 155
 - displaying in a window 156
 - Toshiba
 - Internet Web sites 237
 - Toshiba Accessories
 - information 25
 - Toshiba Forum 235
 - Toshiba online services 235

- Toshiba Power Saver
 - Shut down 100
- Toshiba software offer 123
- TouchPad
 - using 53
- travelling tips 120
- Turn Off 67, 97
 - restarting 102
- turning computer on/off 32, 51, 67, 100
- tutorials 149

U

- Uniform Resource Locator (URL)
 - 152, 164
- uploading 165
- URL (Uniform Resource Locator)
 - 152, 164
- USB ports 29, 30
- USB-compatible
 - keyboard
 - connecting 61
- using
 - modem 95
 - PC Cards 171
 - wireless mouse and control
 - buttons 125
- using the wireless keyboard 76
- utilities
 - Power Management 176
 - Toshiba Power Saver 100

V

- video features
 - exploring 165
- video projector
 - adjusting display 66
 - connecting 65
- video/audio out jack 29
- volume control dial 30
- volume, adjusting 170

W

- warranty
 - SelectServ 26
- wav files
 - recording 168
- Web address 128, 164
- Web browsers 162
- Web sites 235
 - Support Online 209
- Web sites, Toshiba 237
- Wi-Fi
 - wireless networking 160
- windows
 - hiding 134
 - repositioning 134
 - resizing 134, 136
- Windows Explorer 132
- Windows Help and Support 124
- Windows XP
 - change date and time settings 143
 - changing the screen saver 141
 - closing programs 137
 - creating a new folder 131
 - creating a text file 129
 - creating shortcuts 138
 - desktop 122
 - Help 147, 208, 209
 - Help and Support 208
 - opening a Web page 128
 - problem solving 206
 - Recycle Bin 144
 - removing objects 144
 - resizing or moving windows 134, 136
 - special features 151
 - starting programs 132
 - System Restore 146
 - tours and tutorials 149
 - turning off computer 150
- WinDVD 167, 179

- advanced features 195
- color balance 201
- control panel 182
- controls are disabled 220
- customizing 188
- error messages 224
- help 202
- Internet browser, launching 202
- not functioning properly 224
- pan 201
- performance is poor 221
- playing DVDs 179
- playlists 186
- properties, audio 190
- properties, display 192
- region codes 189
- slow playback 221
- starting 180
- status bar 181
- system requirements 224
- toolbar 181
- video content poor 223
- video window, maximizing 185
- zoom 200, 201
- wireless antenna
 - on-off switch 28
- wireless features
 - Wi-Fi 161
- wireless keyboard
 - using 76
- wireless mouse
 - installing batteries 55
 - Reset button 56
 - using 55, 125
- wireless networking 160
- Wizards
 - Add Printer 62
 - Network Setup 96
 - New Connection Wizard 160
- World Wide Web 162